

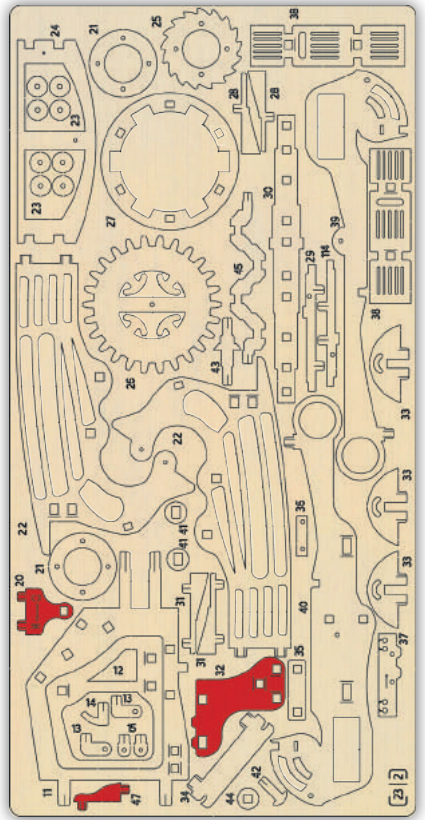

Wood Trick®

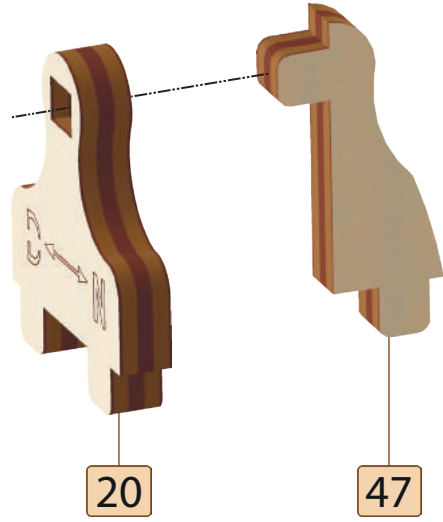

2



20

47

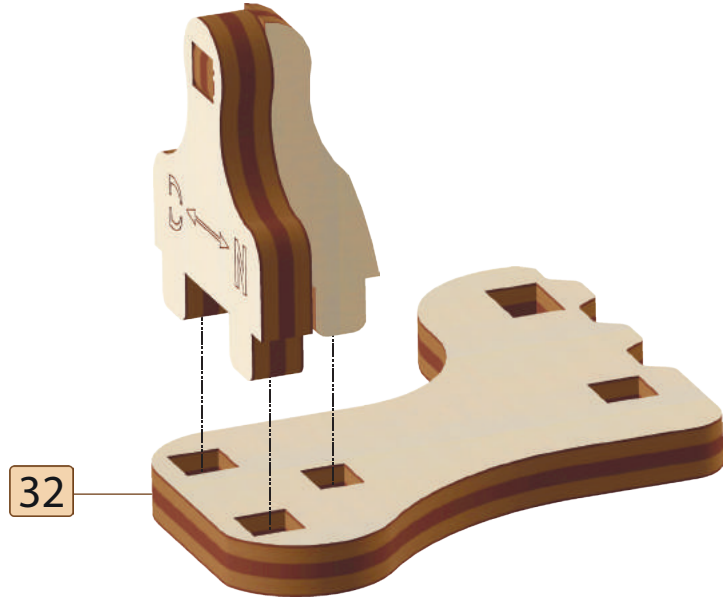

32

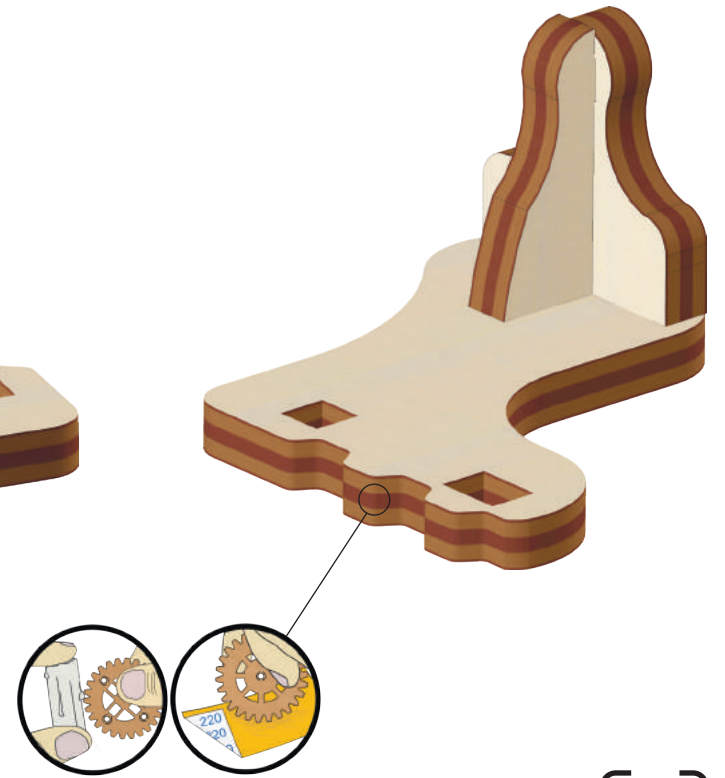

[1]

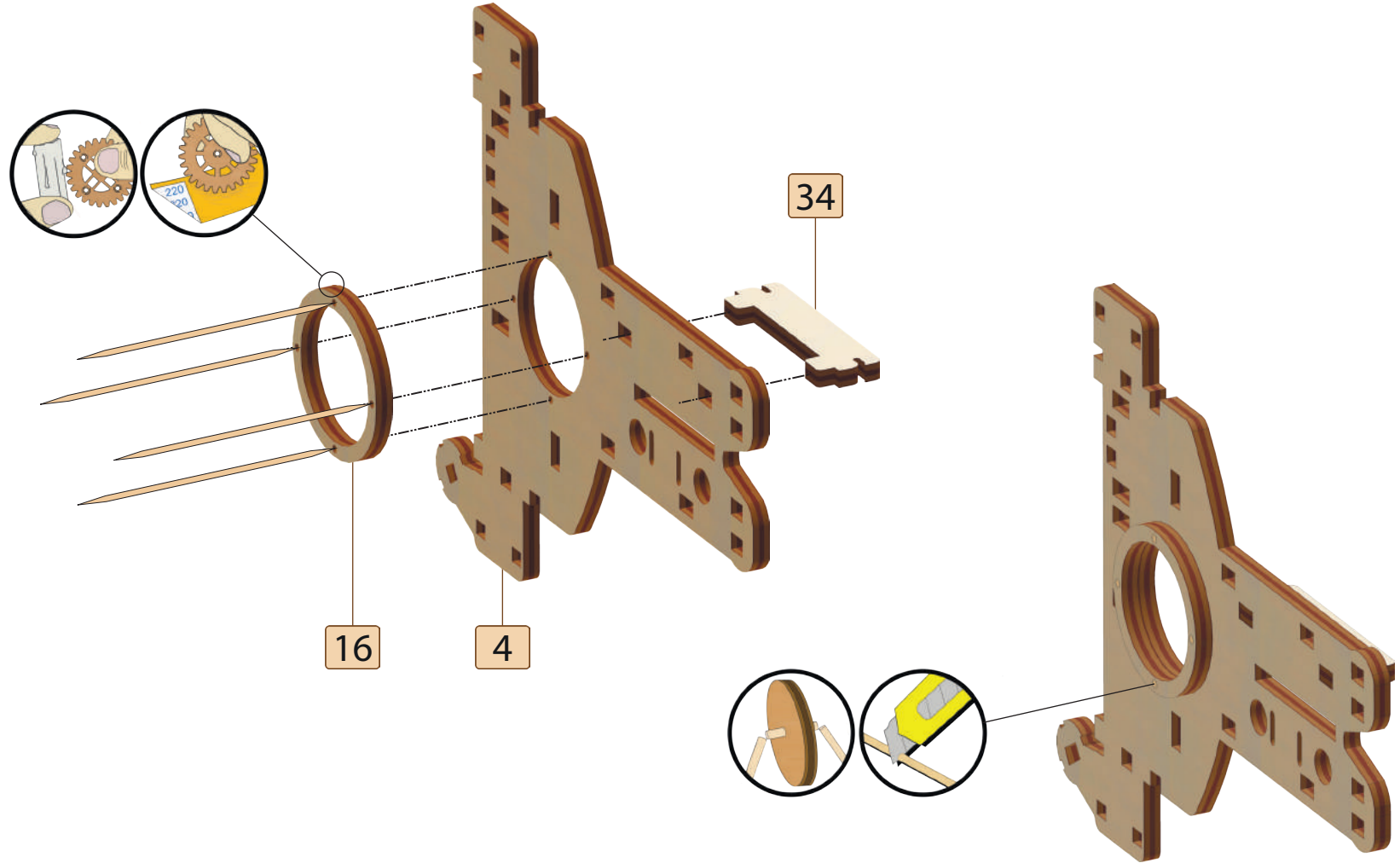
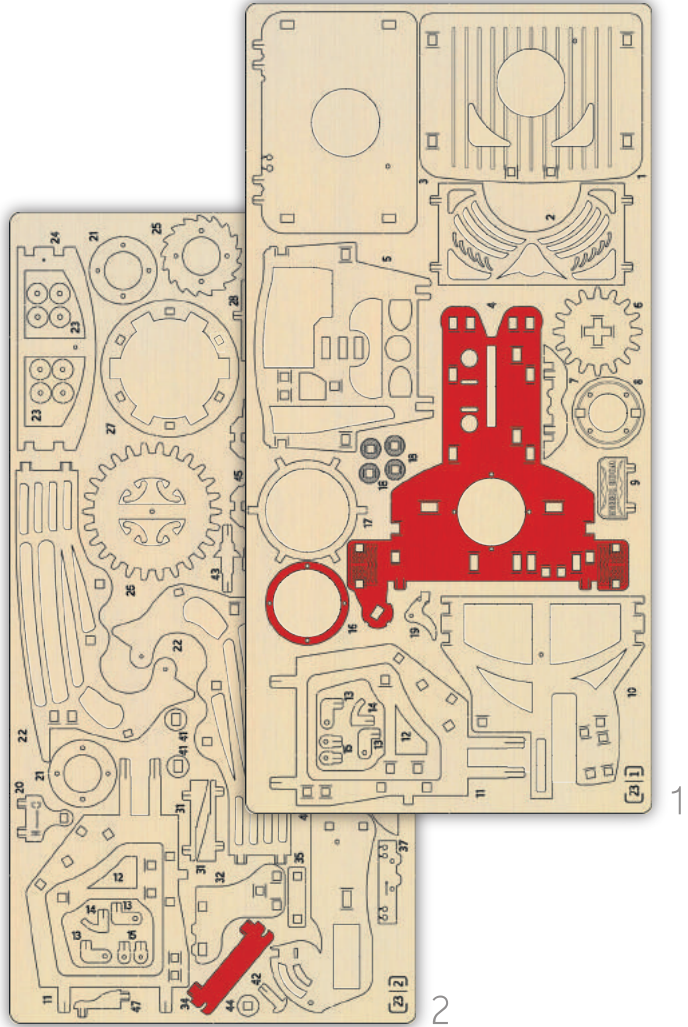

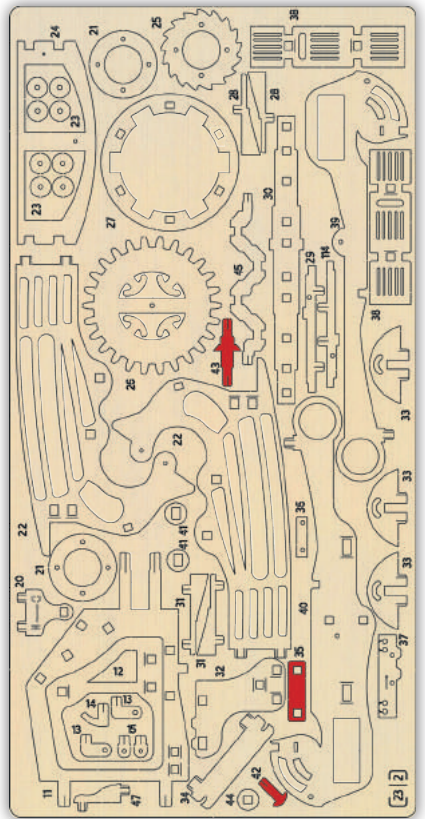

2

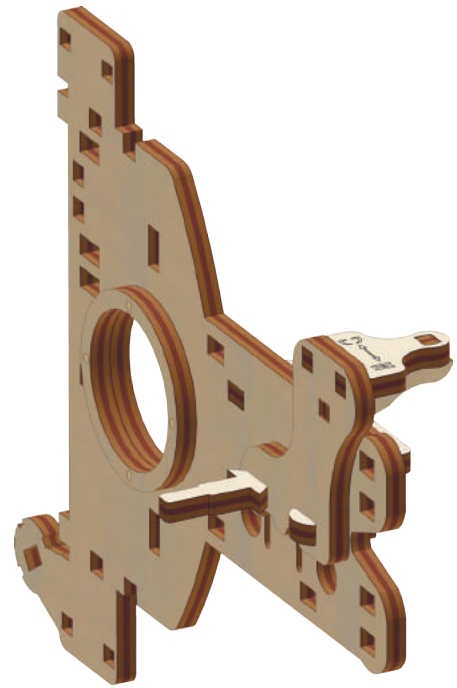
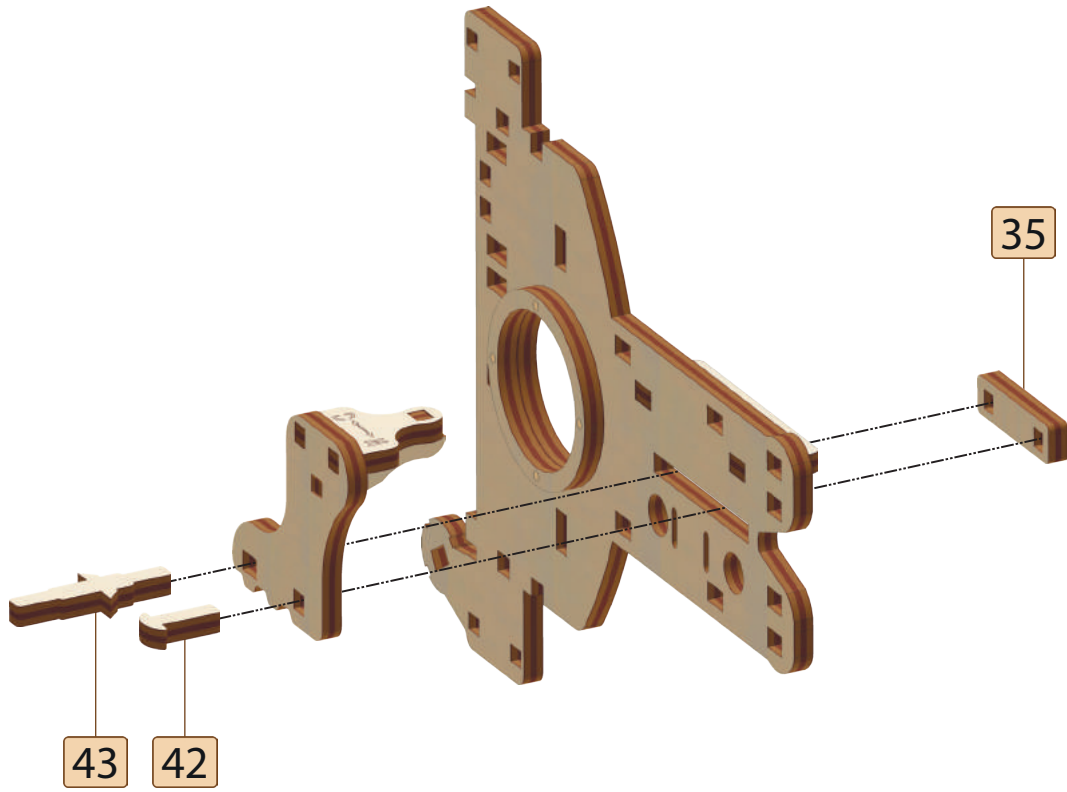

[ 3 ]

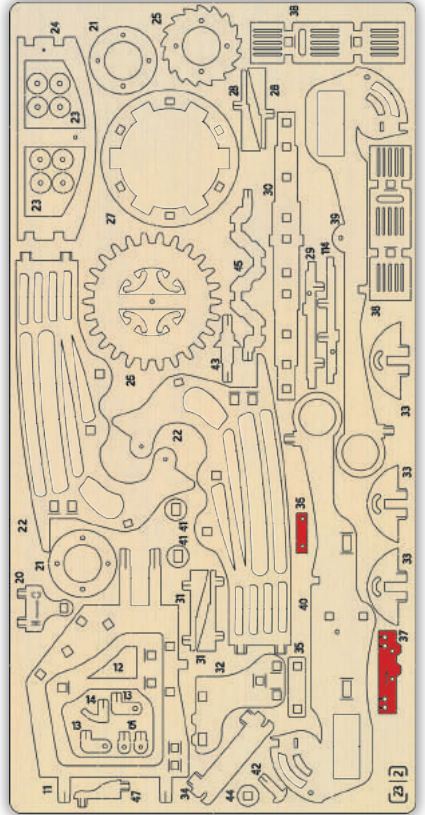

2

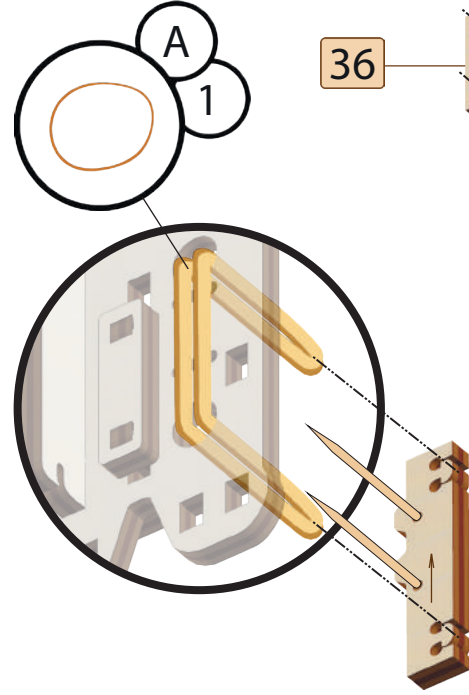
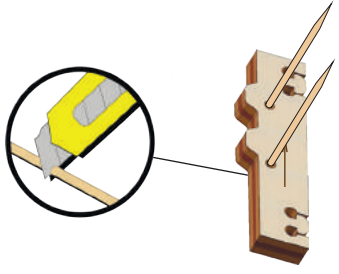
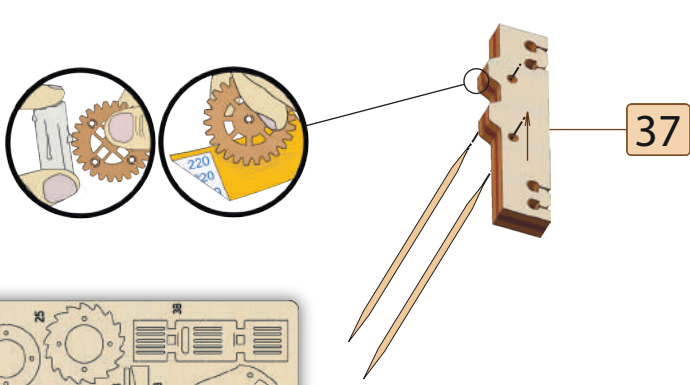

36

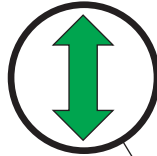
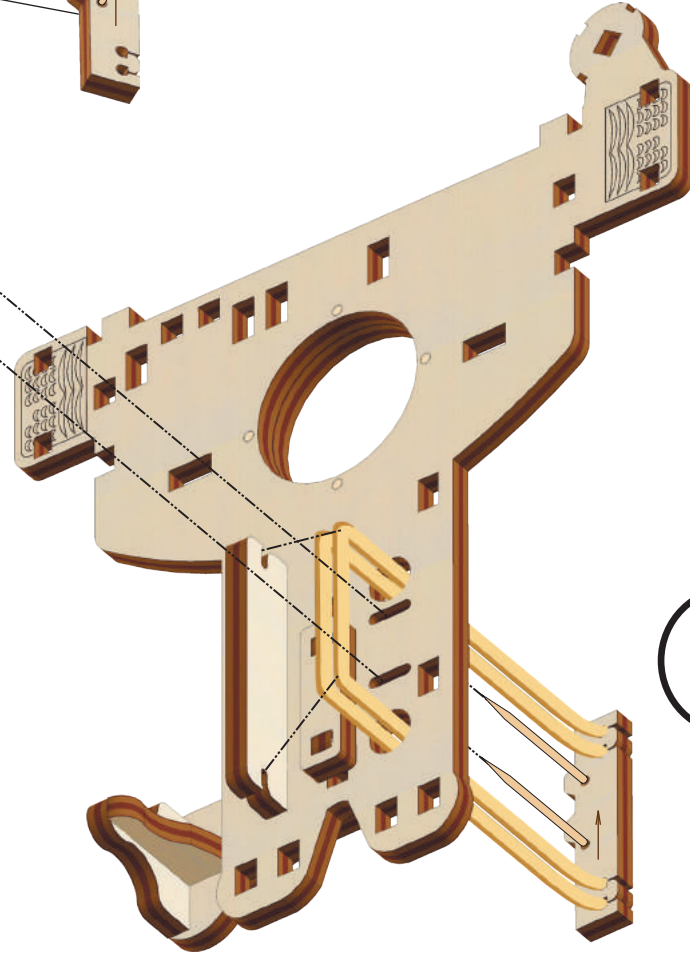

x10

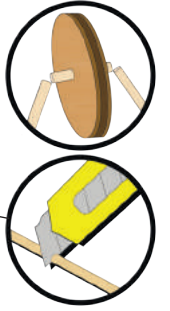
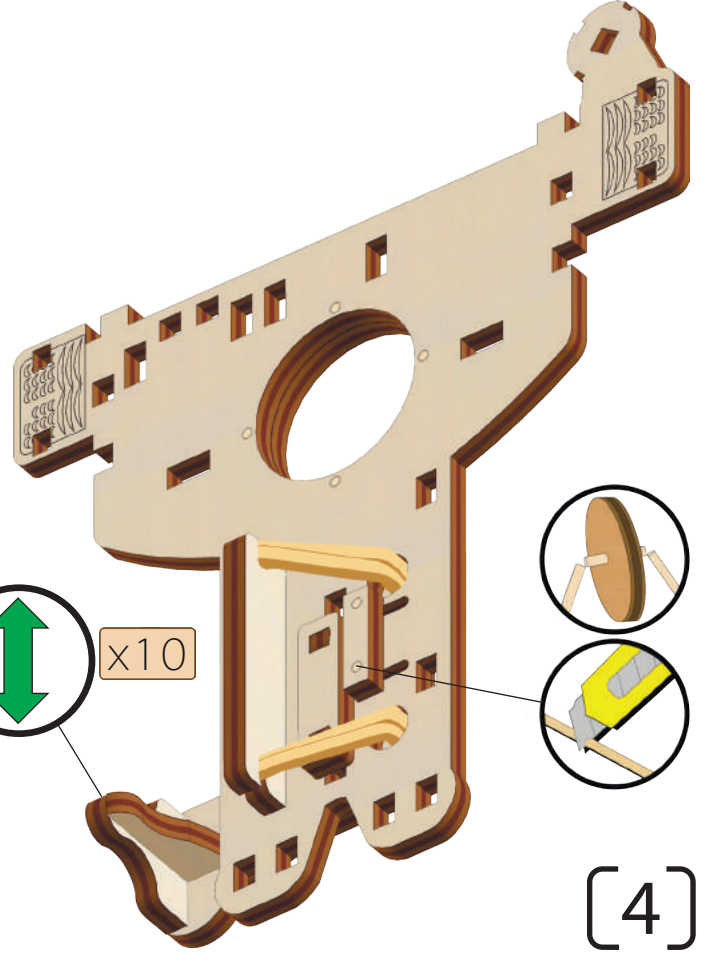

[4]

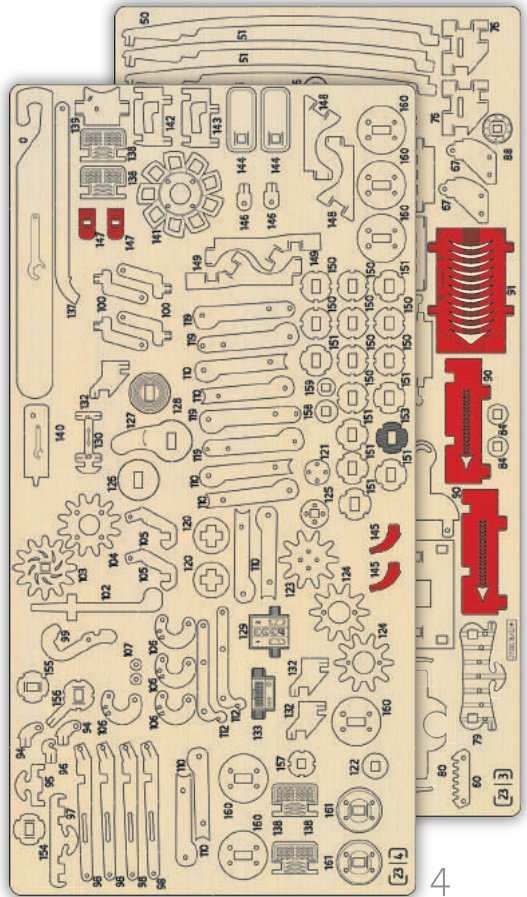

3

4

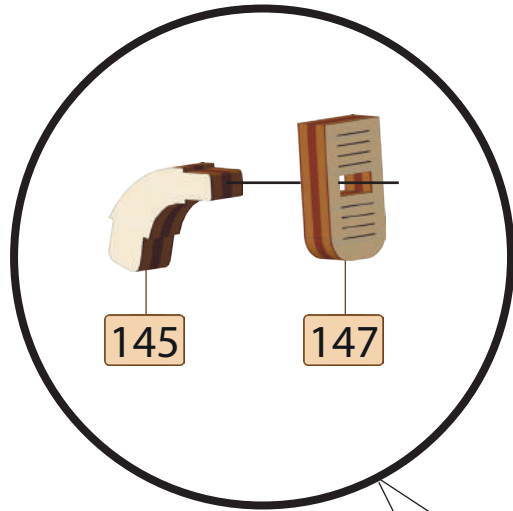

145

147

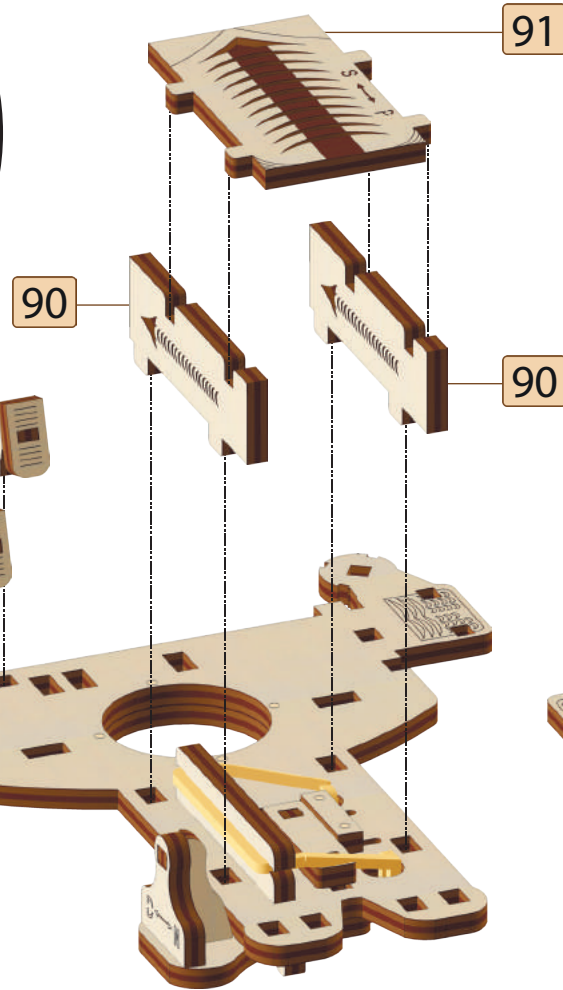

90

91

90

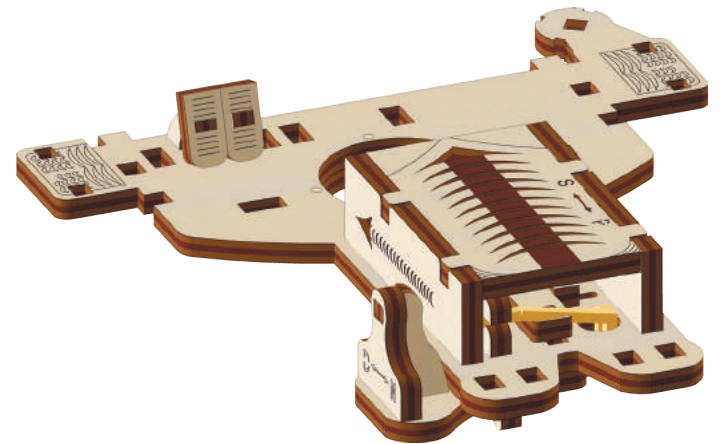

[5]

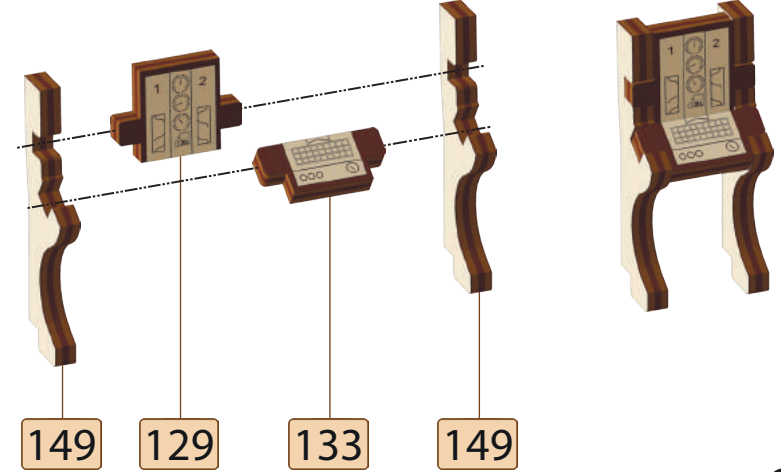
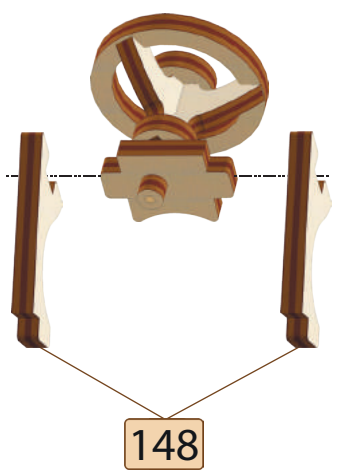
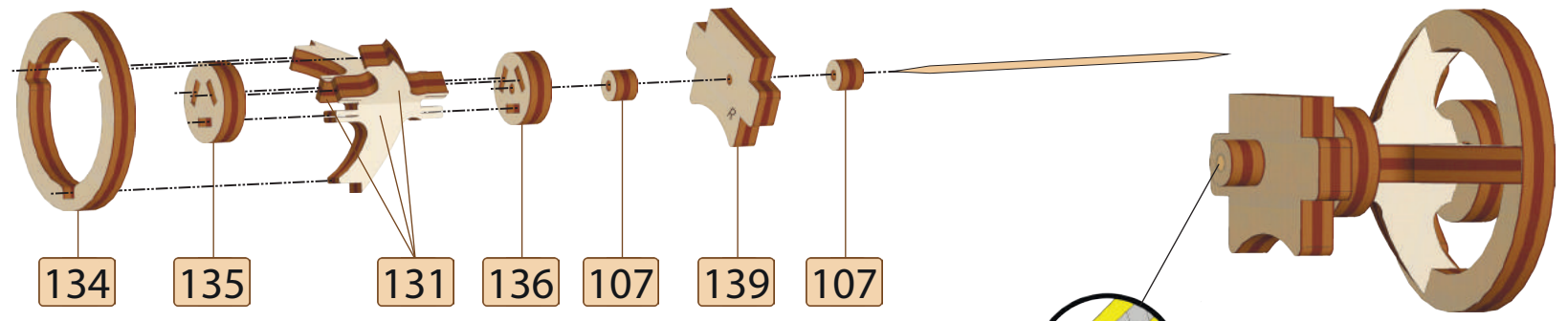
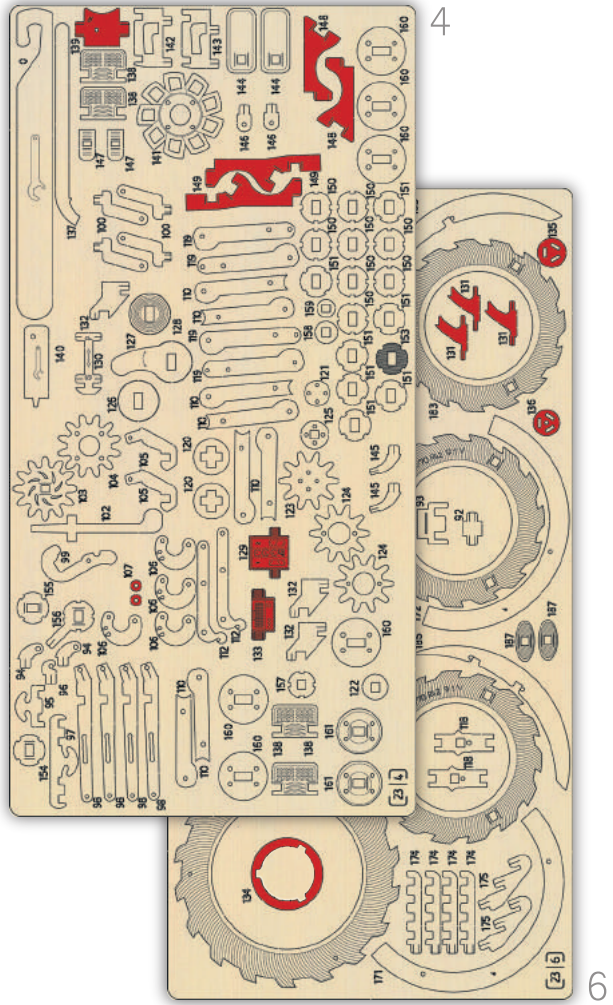





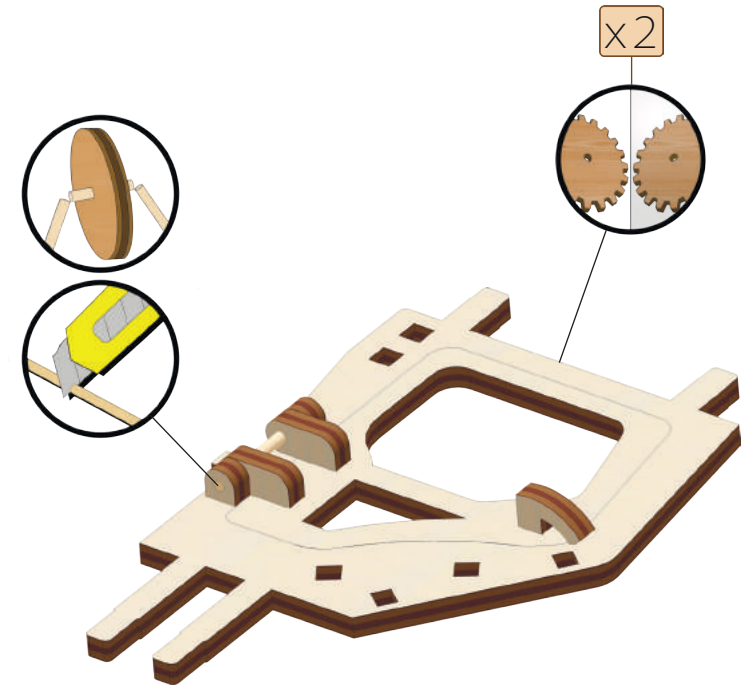
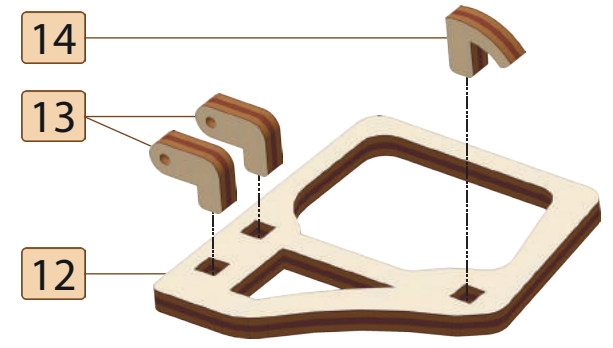
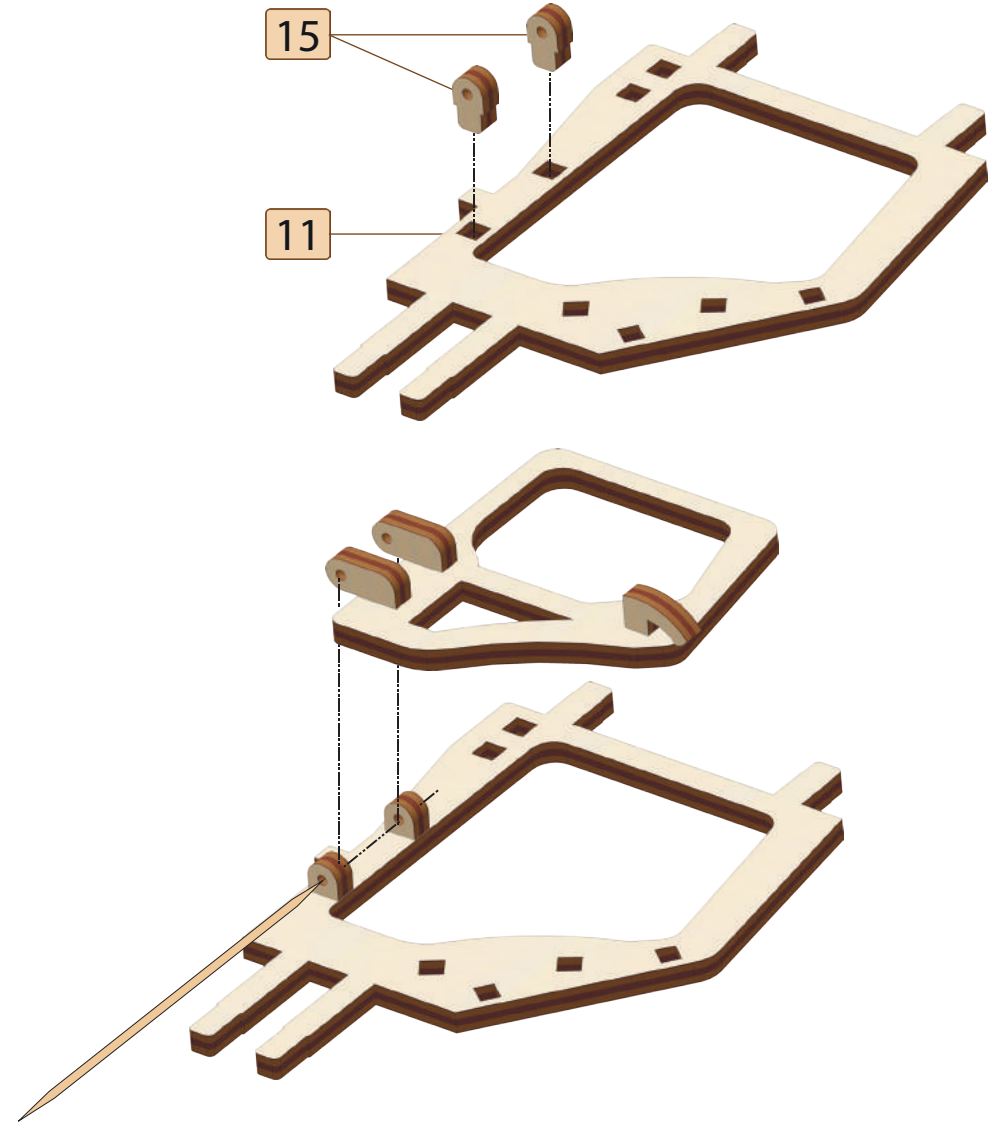
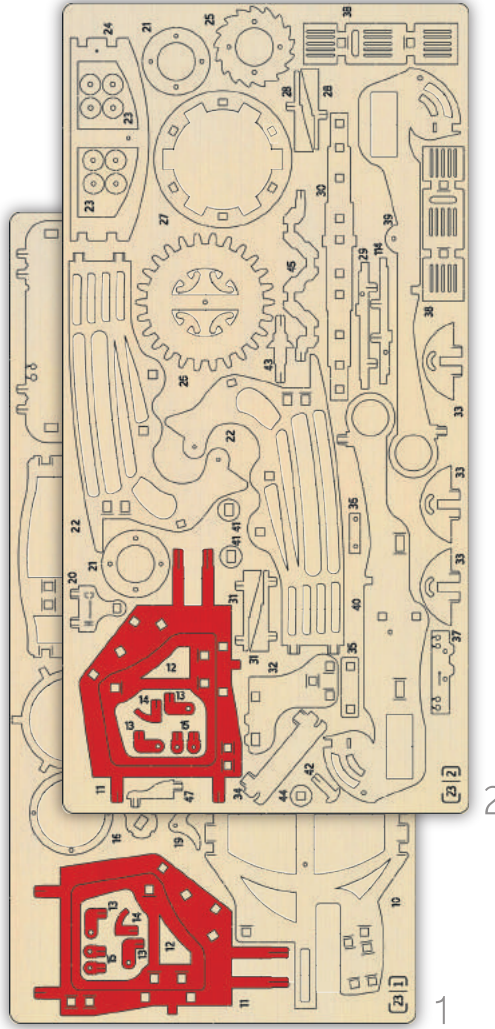

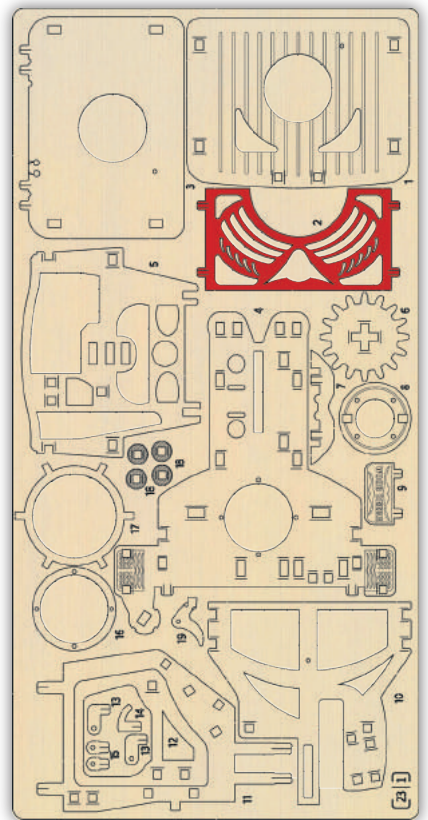

1

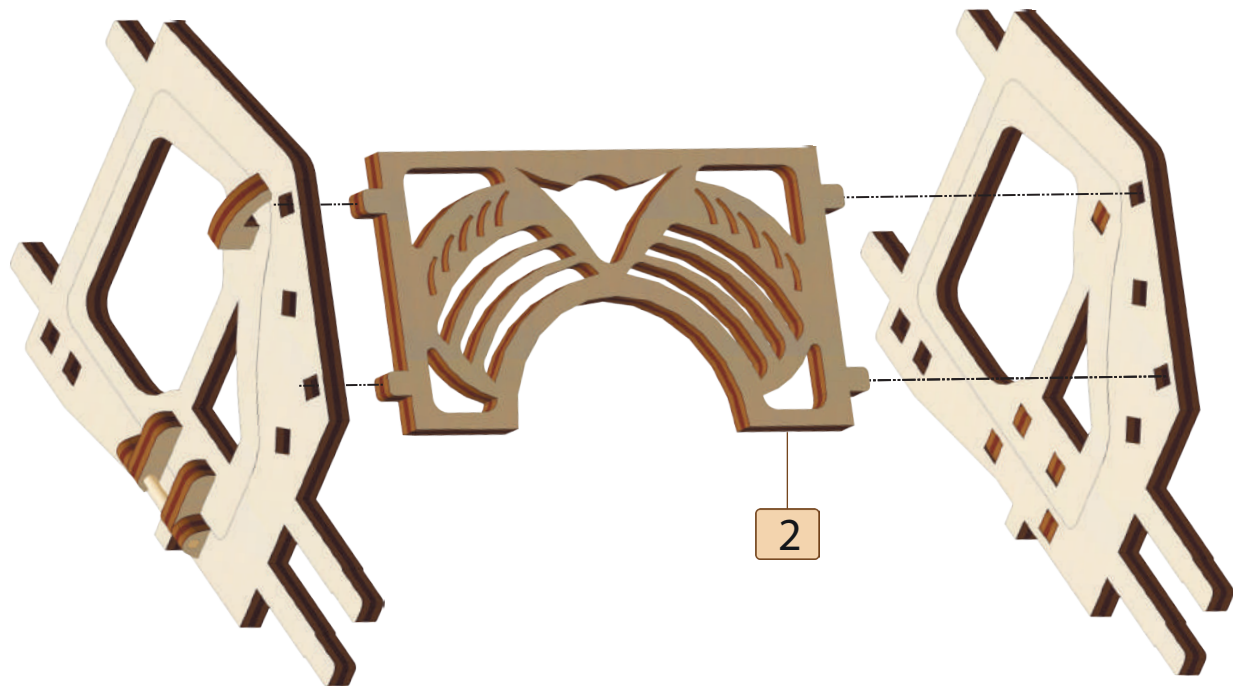

2



[9]

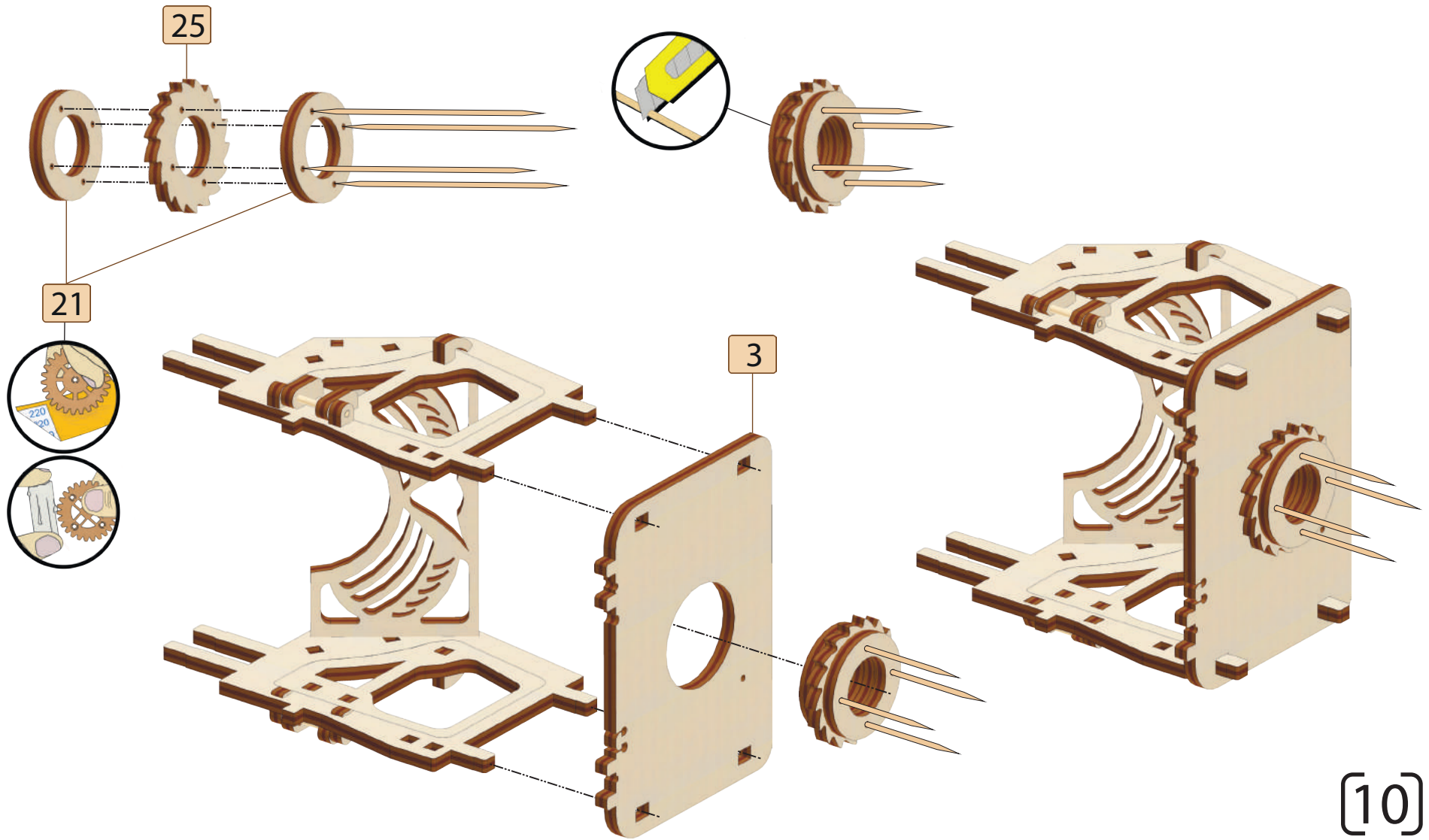
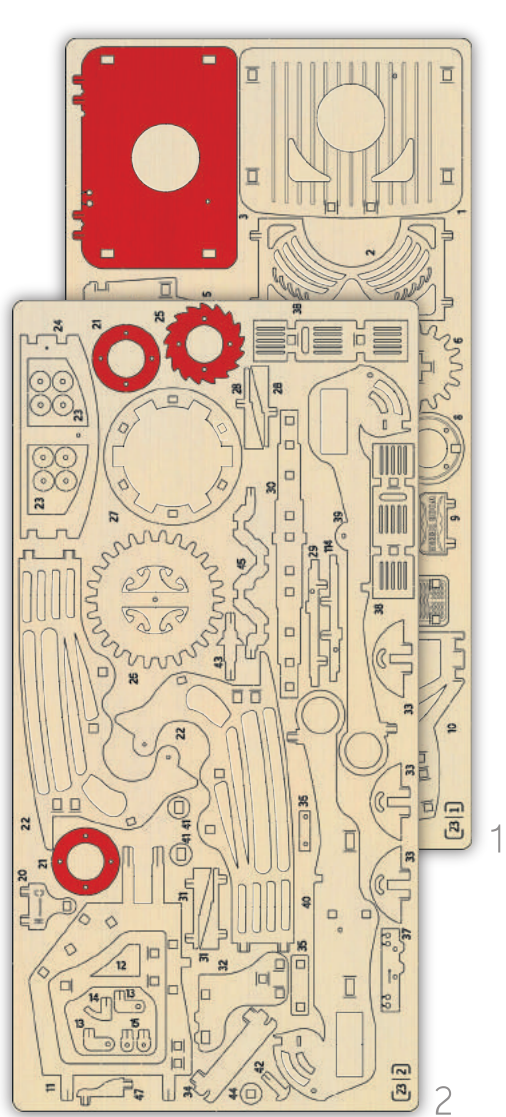

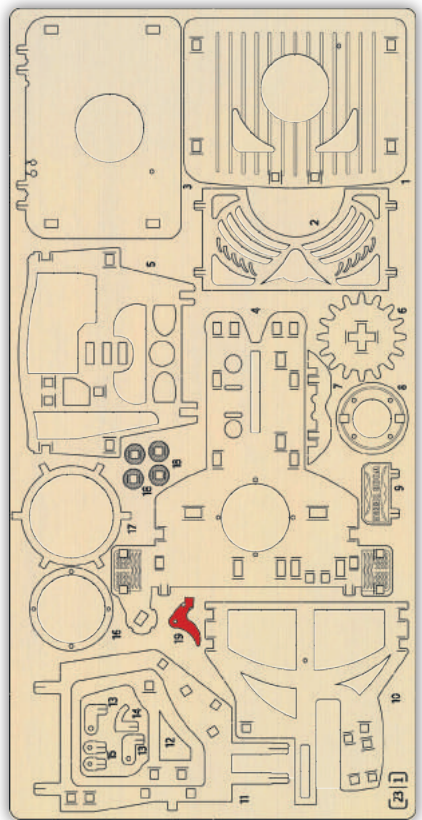

1

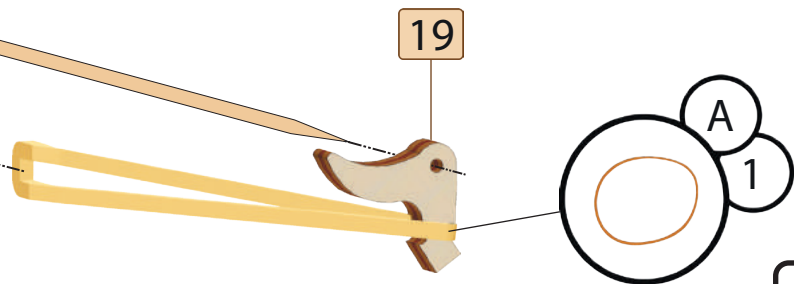
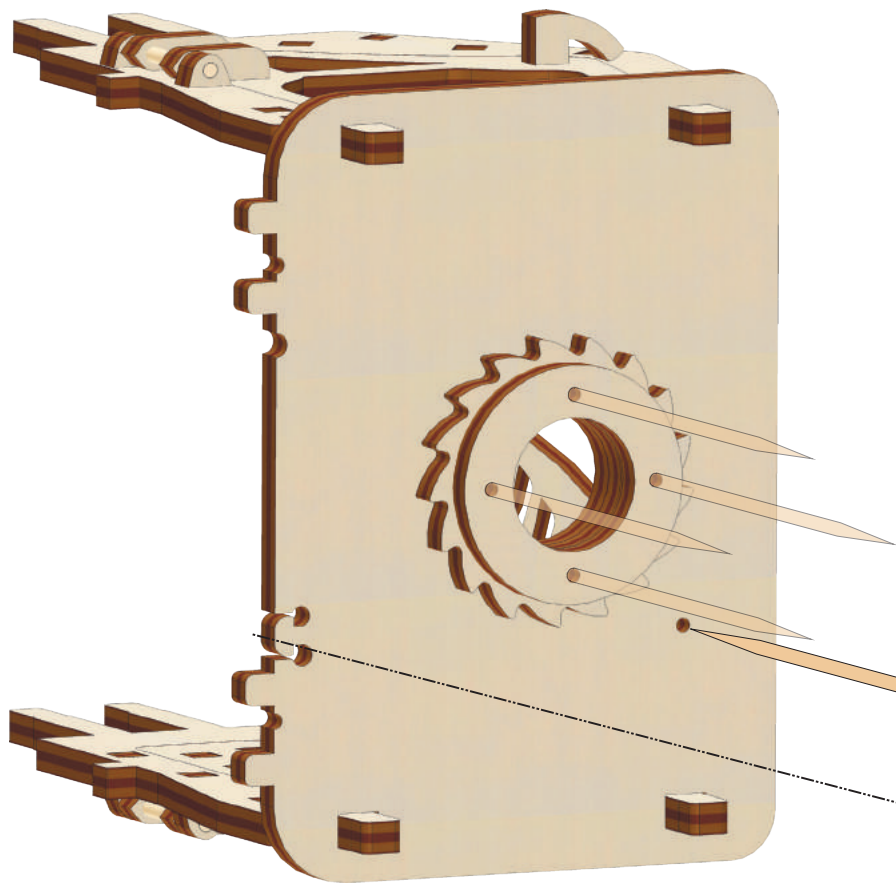

[11]

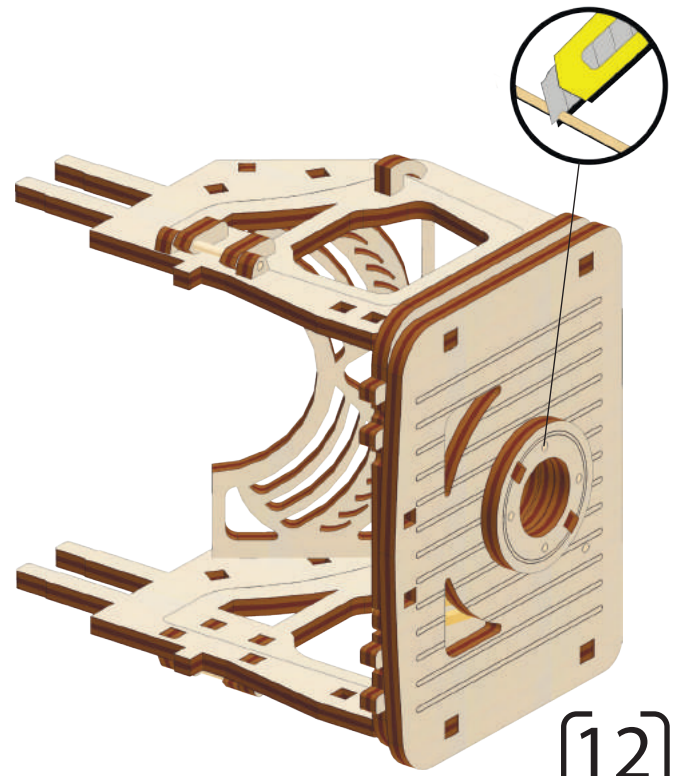
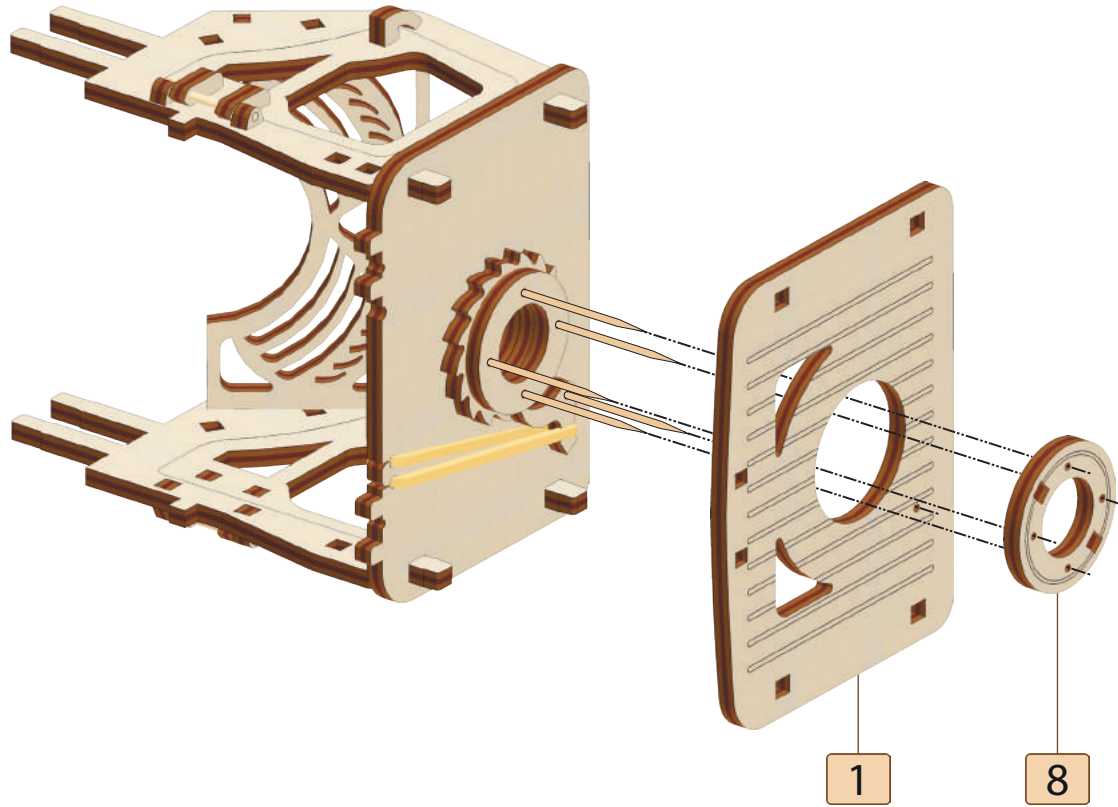
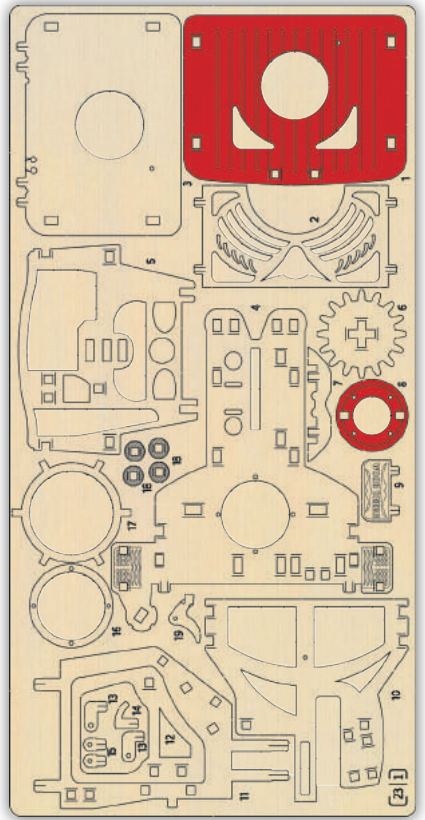

12



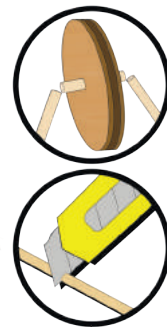
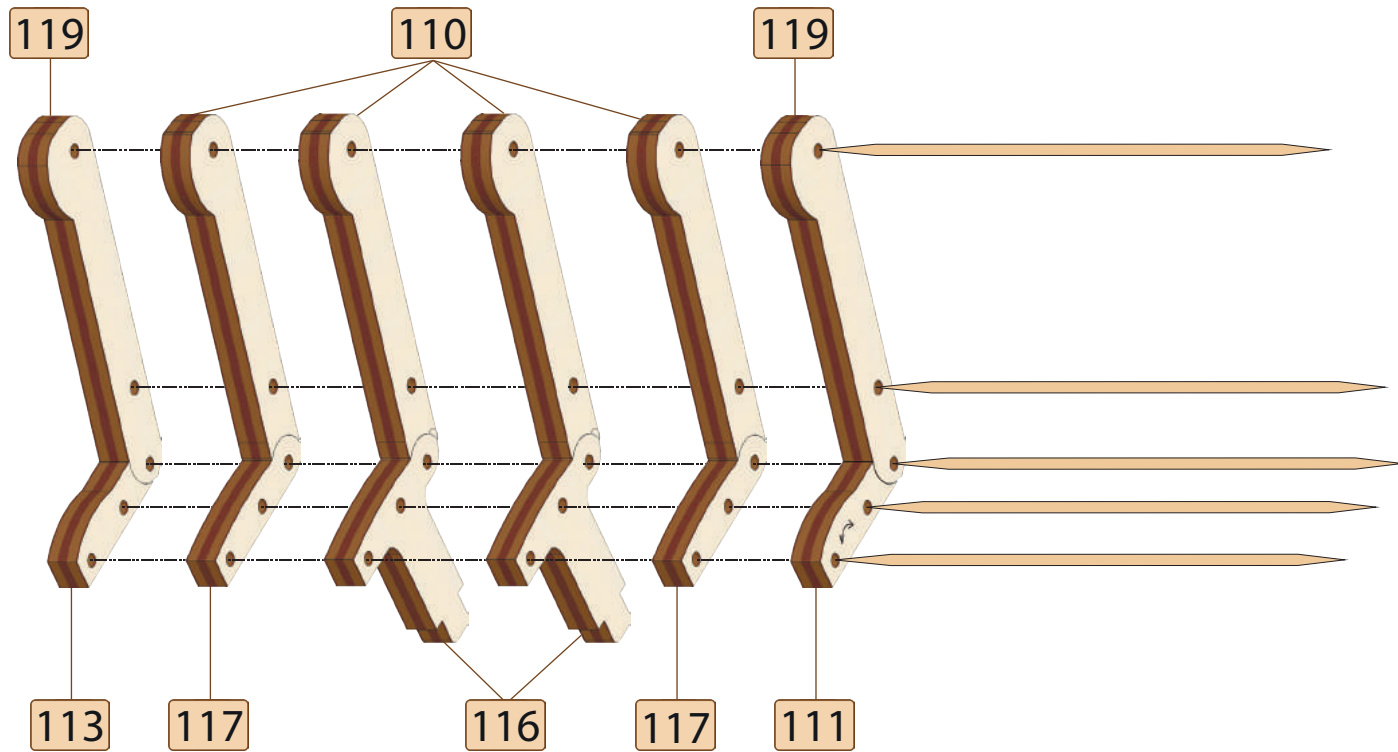
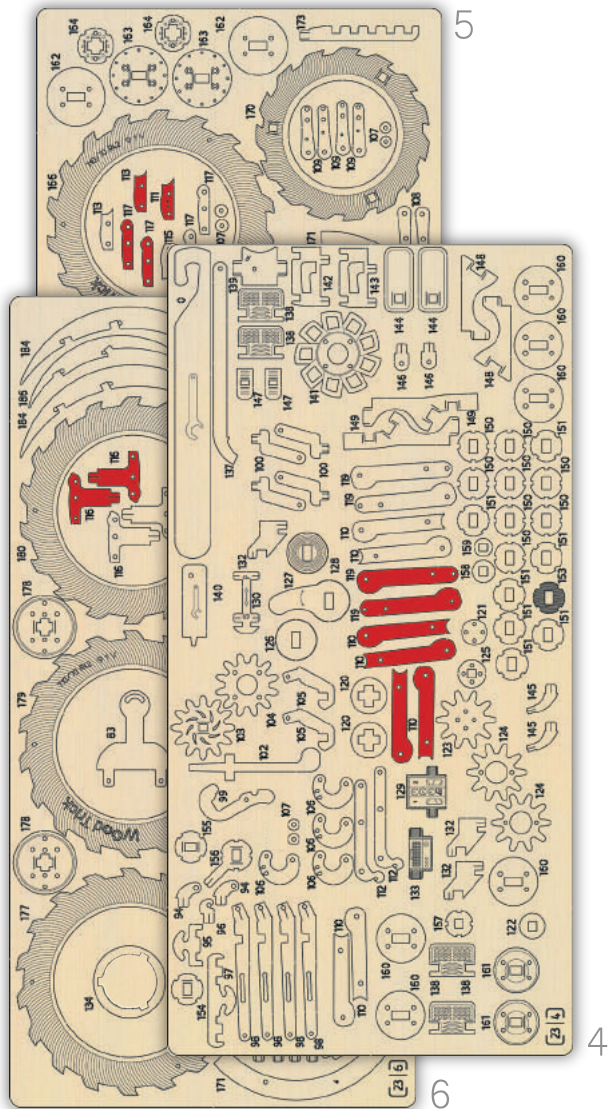

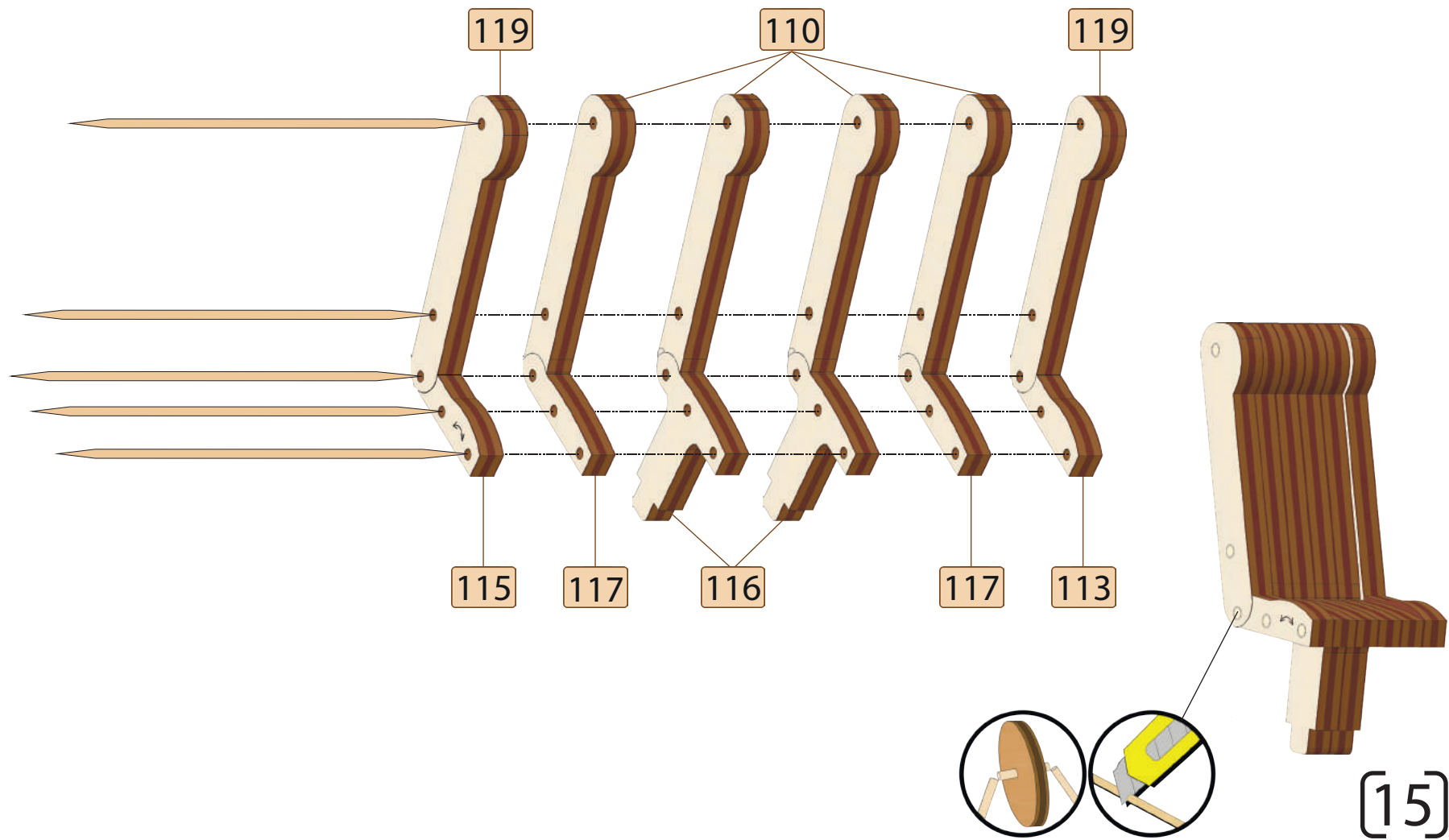
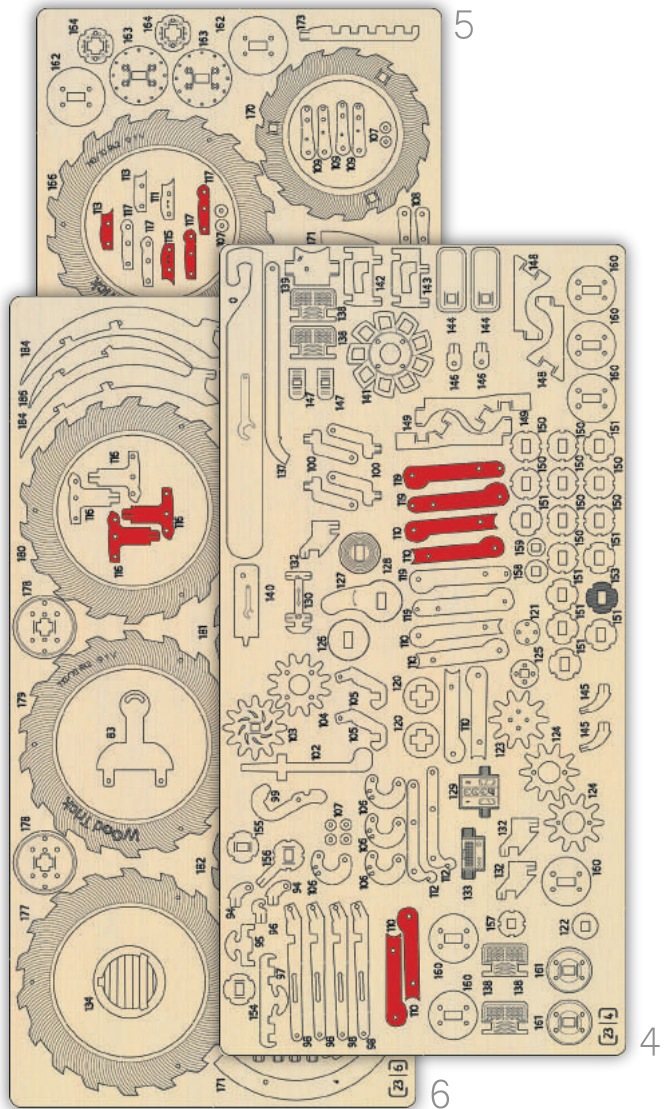



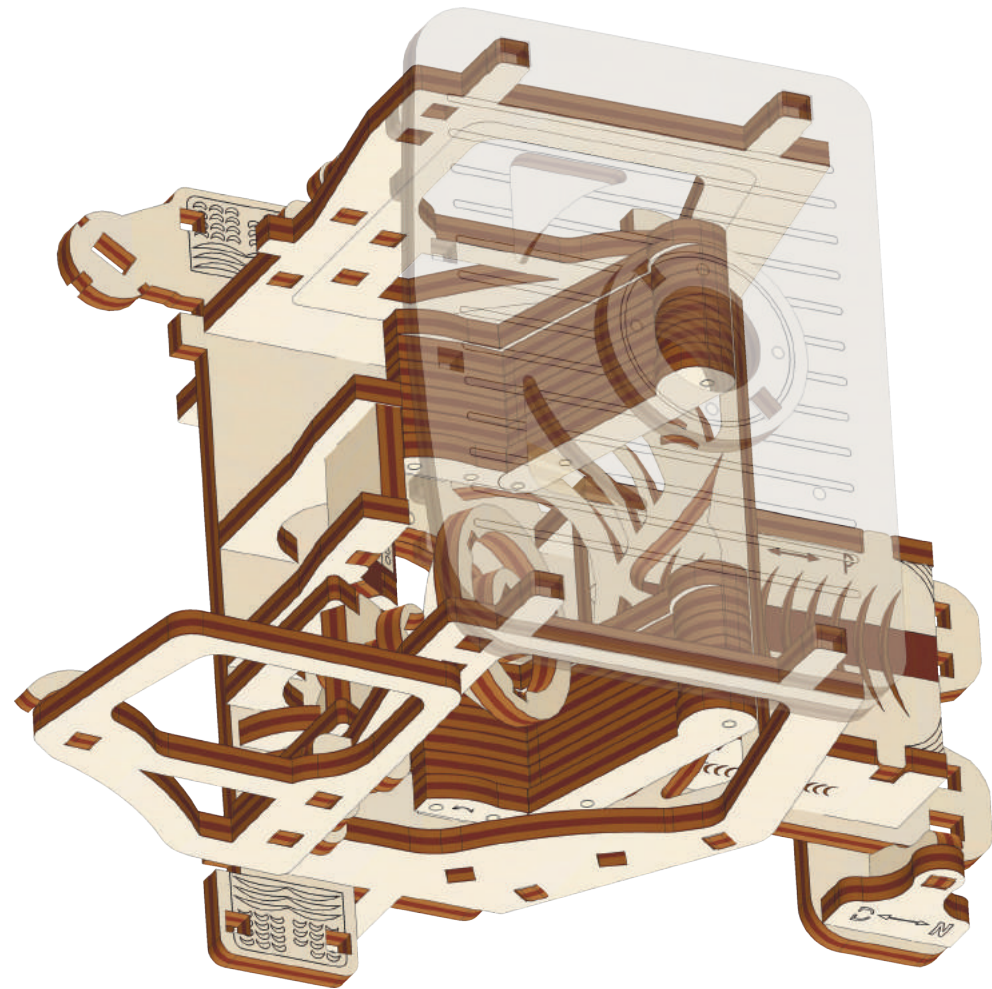
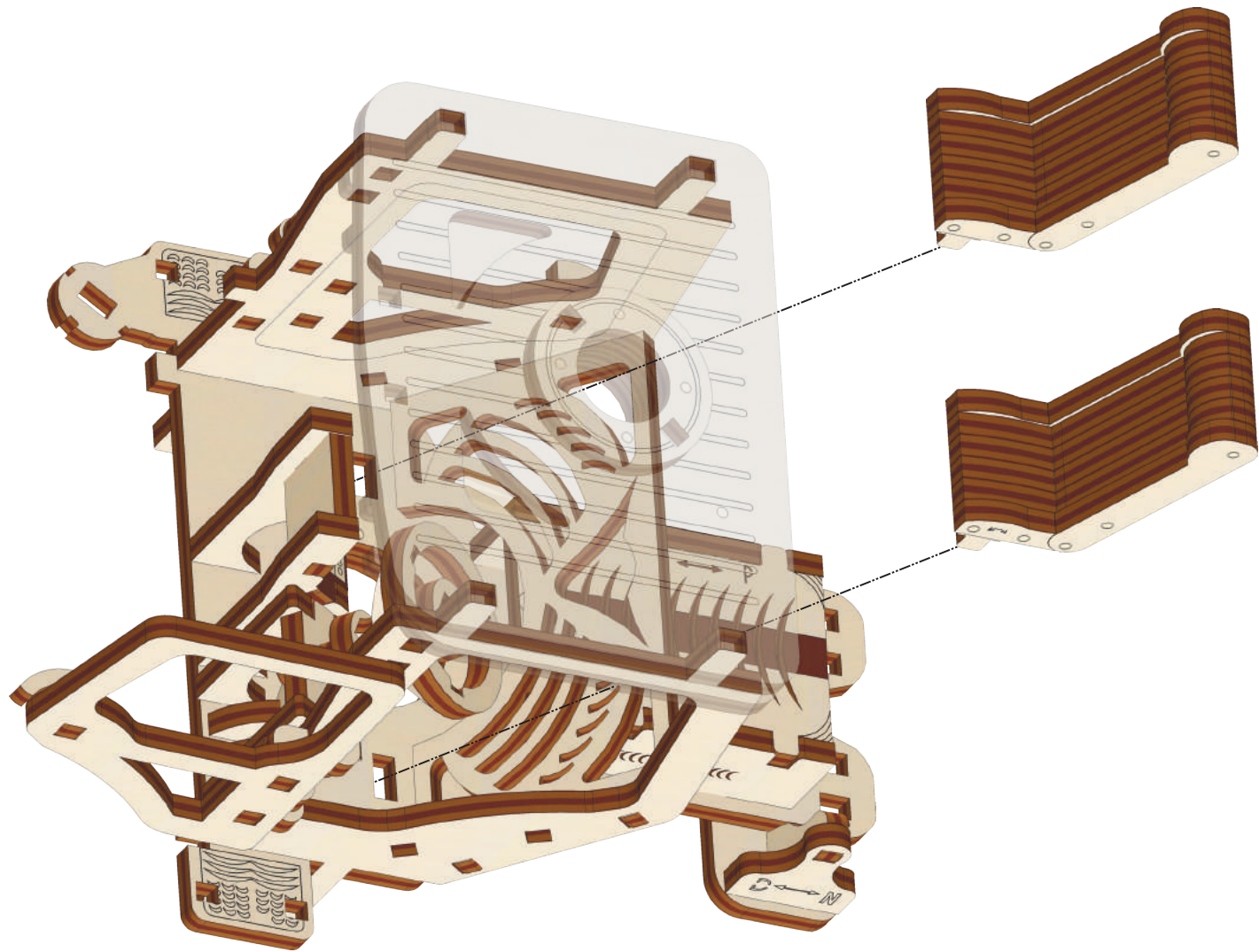

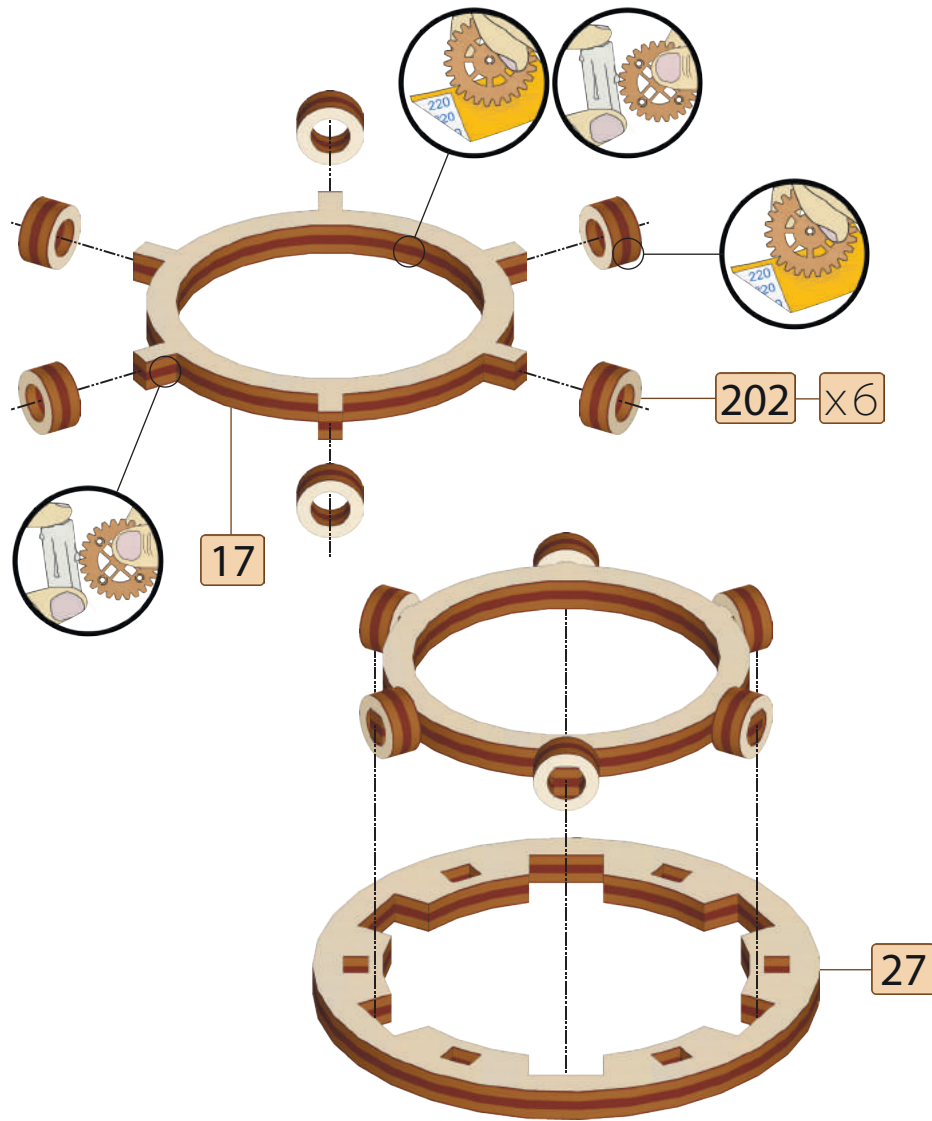
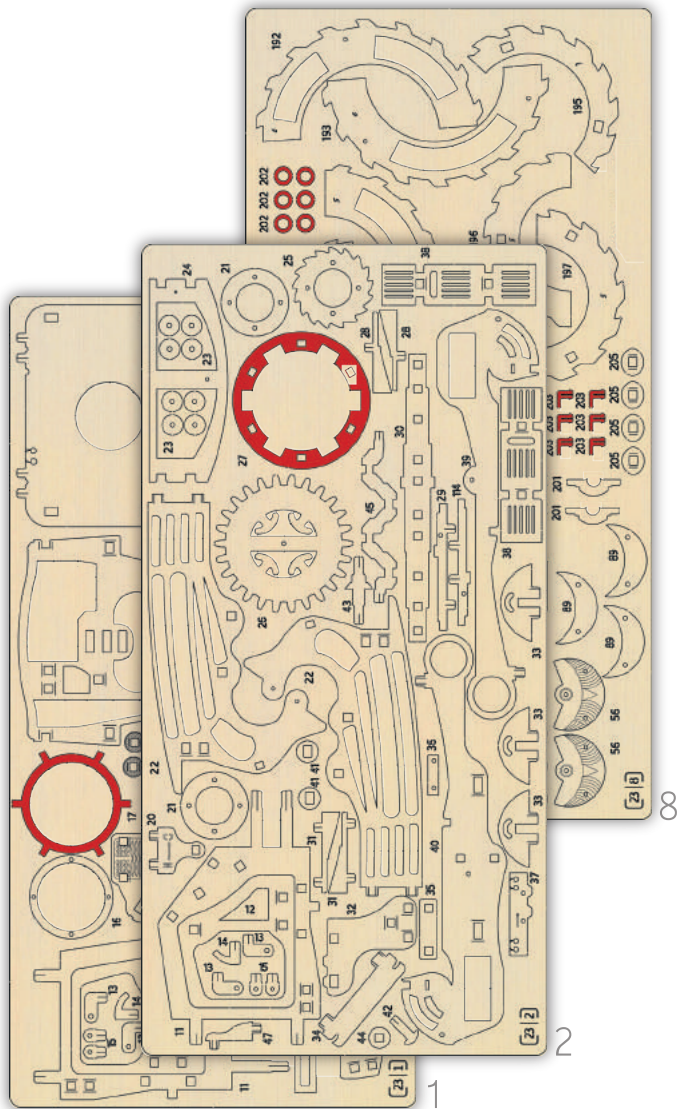

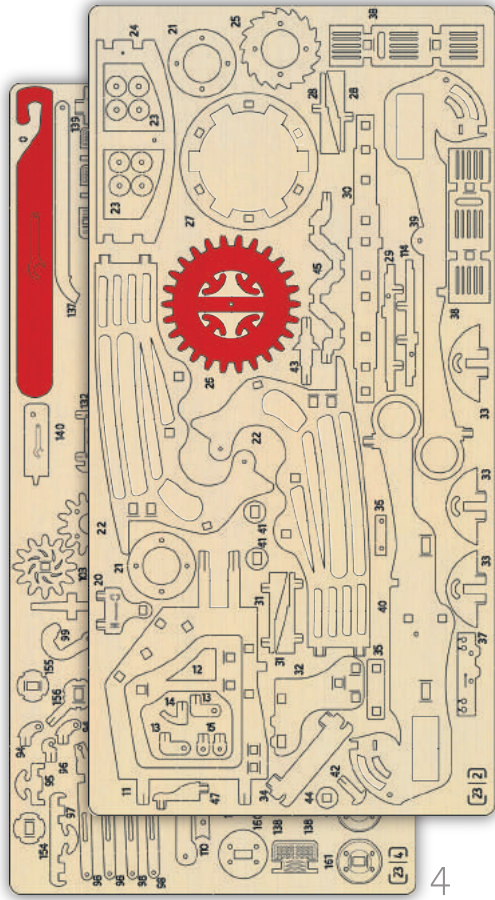

2

4



26

0

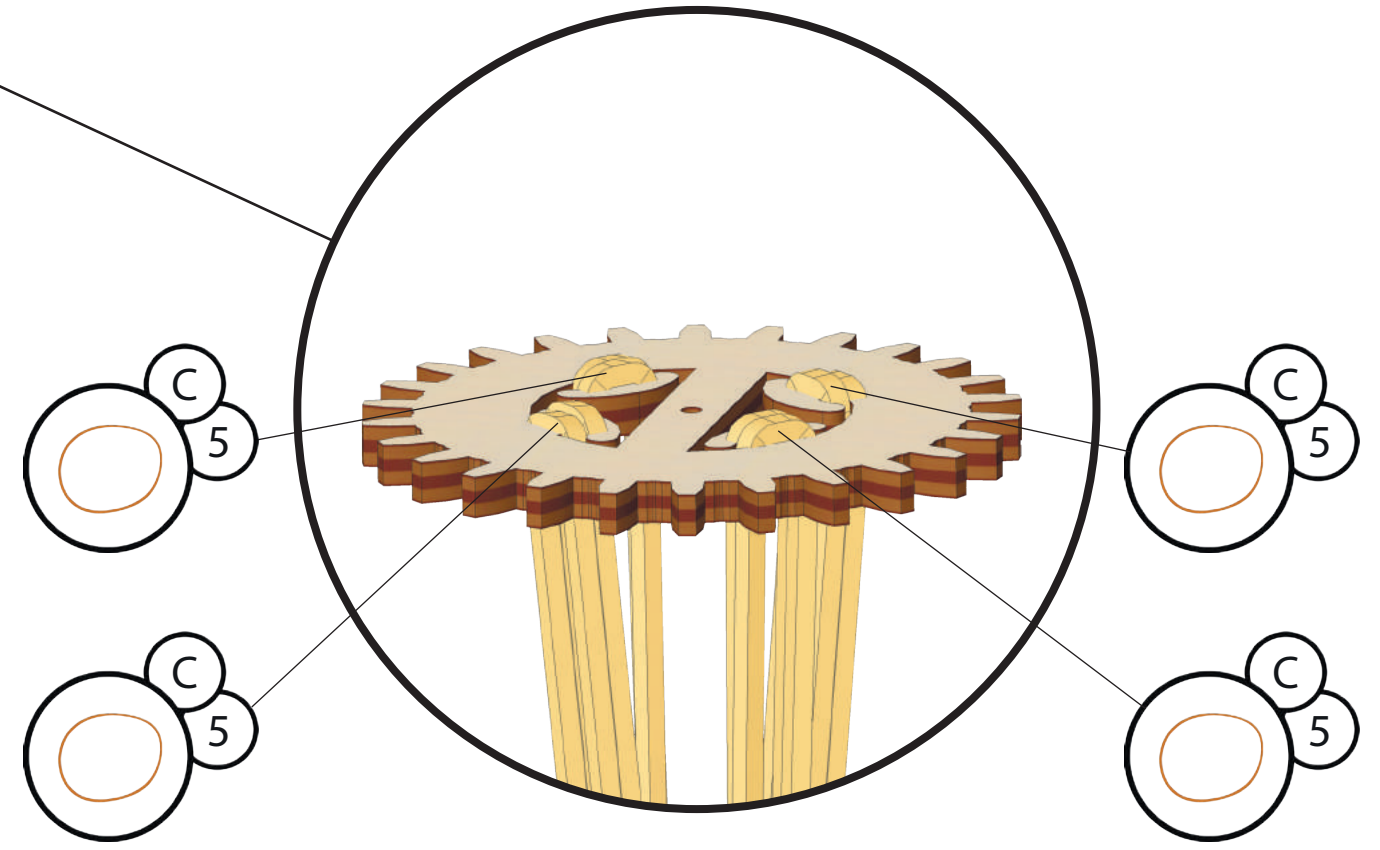

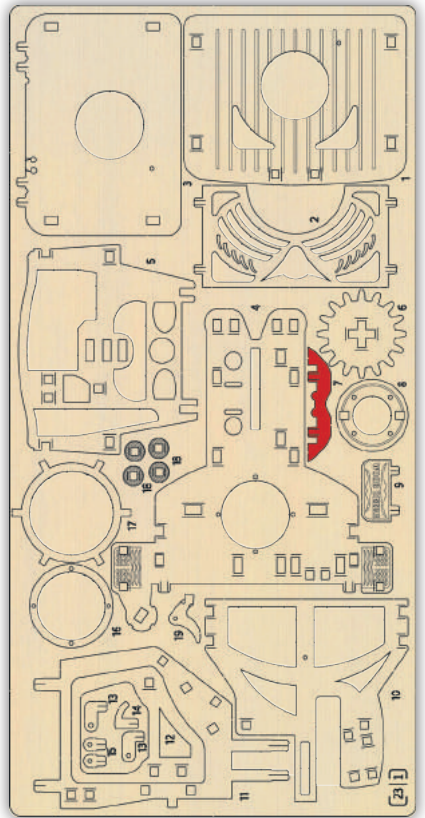

1

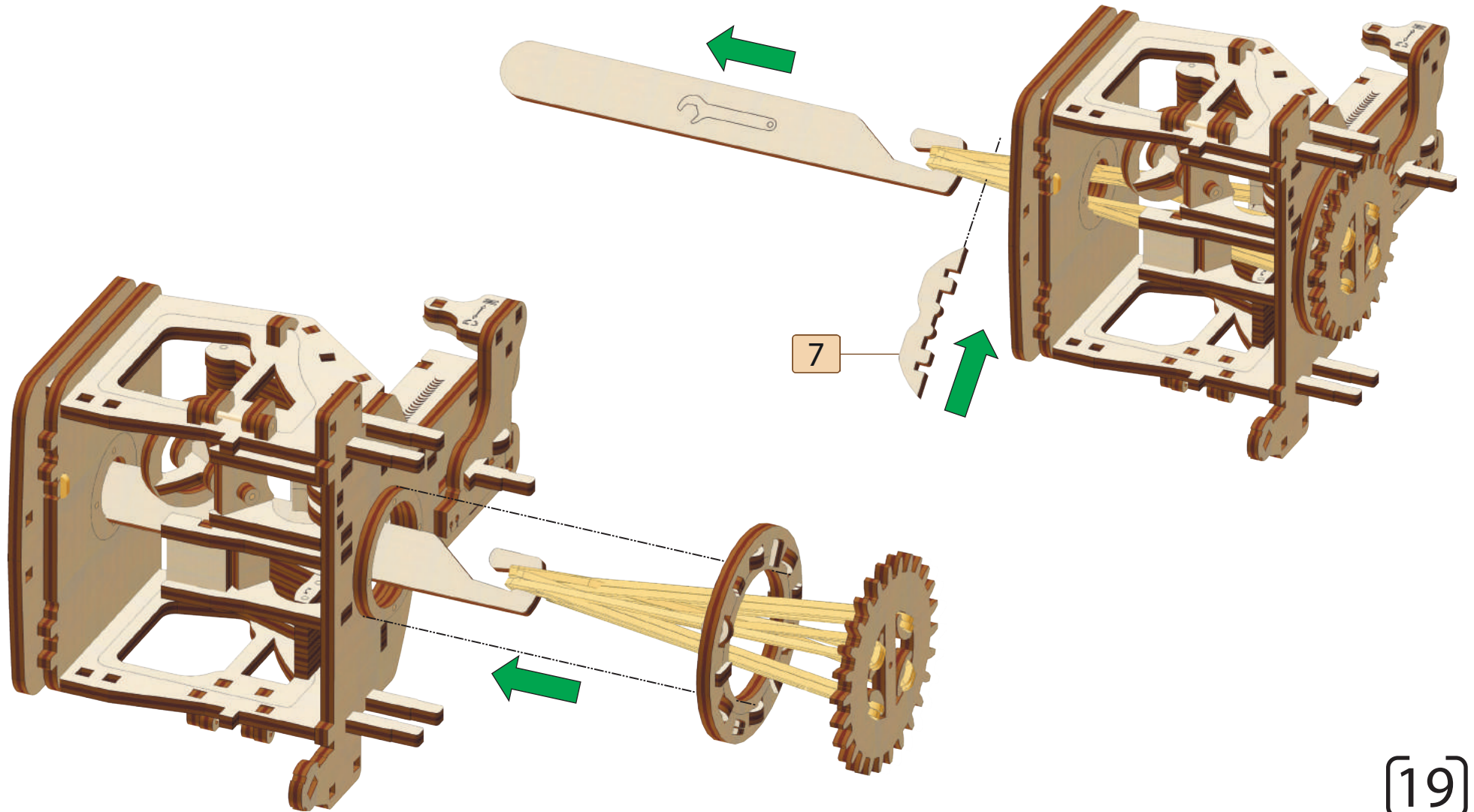

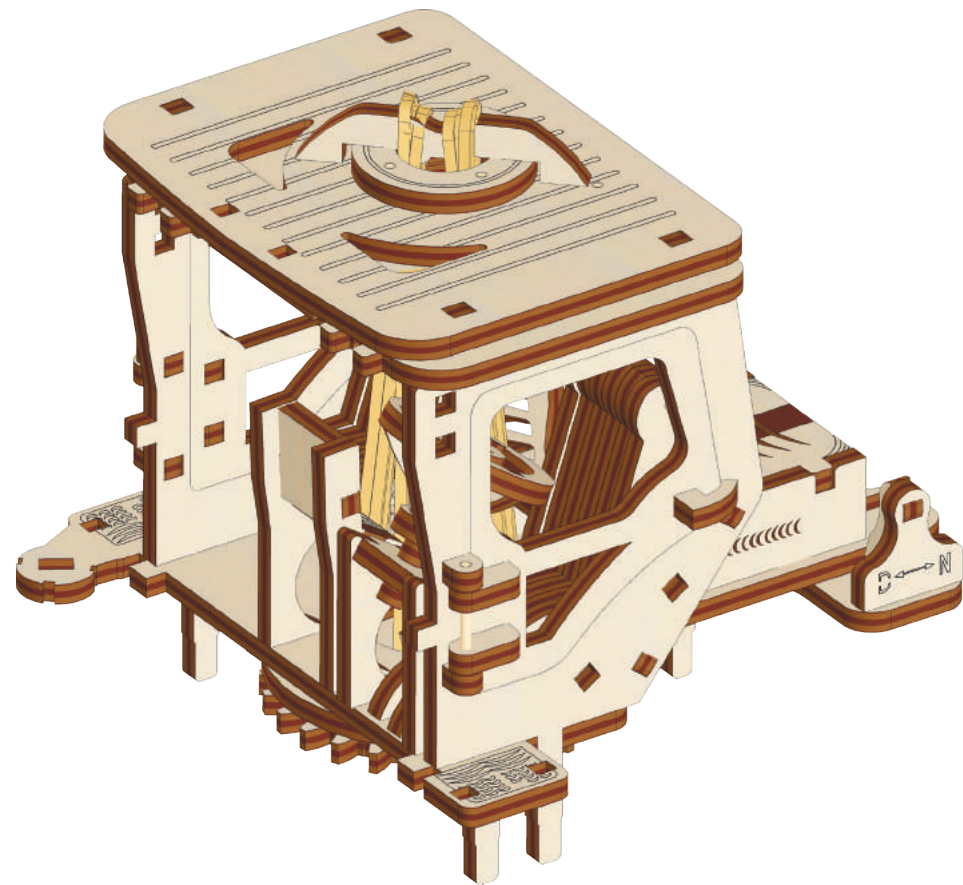
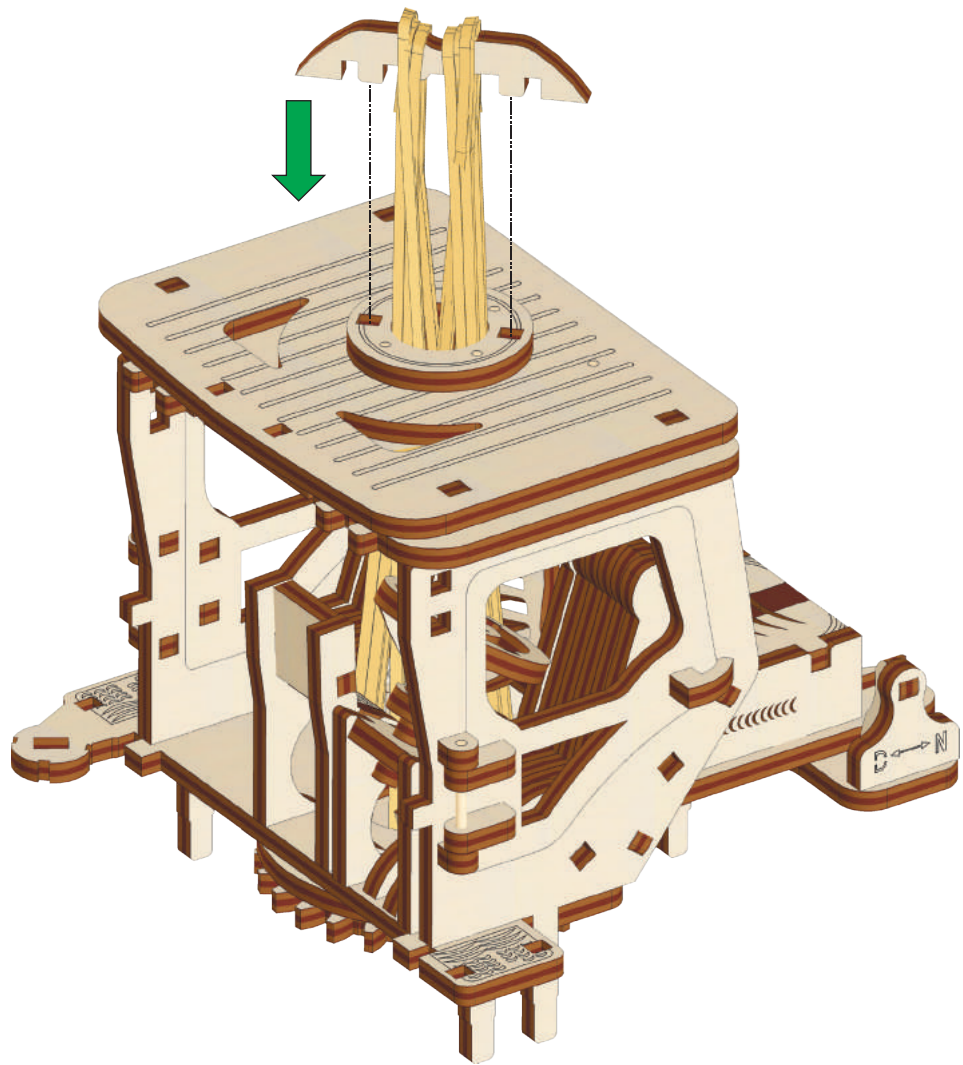

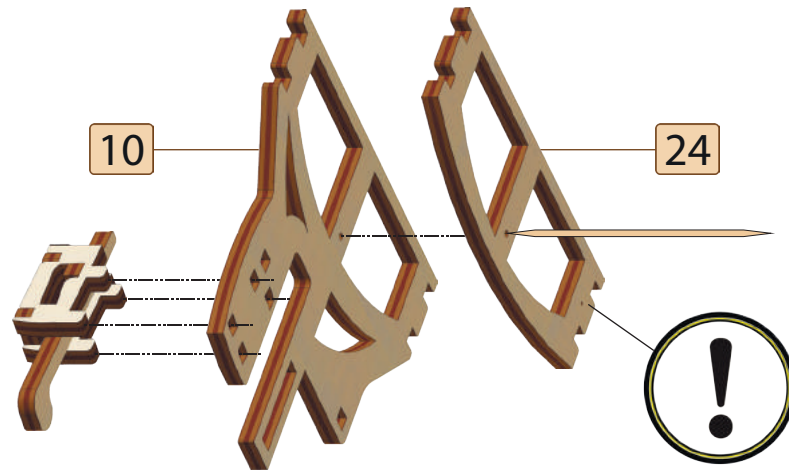
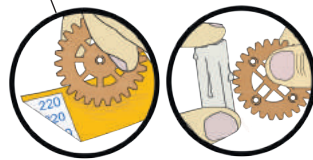
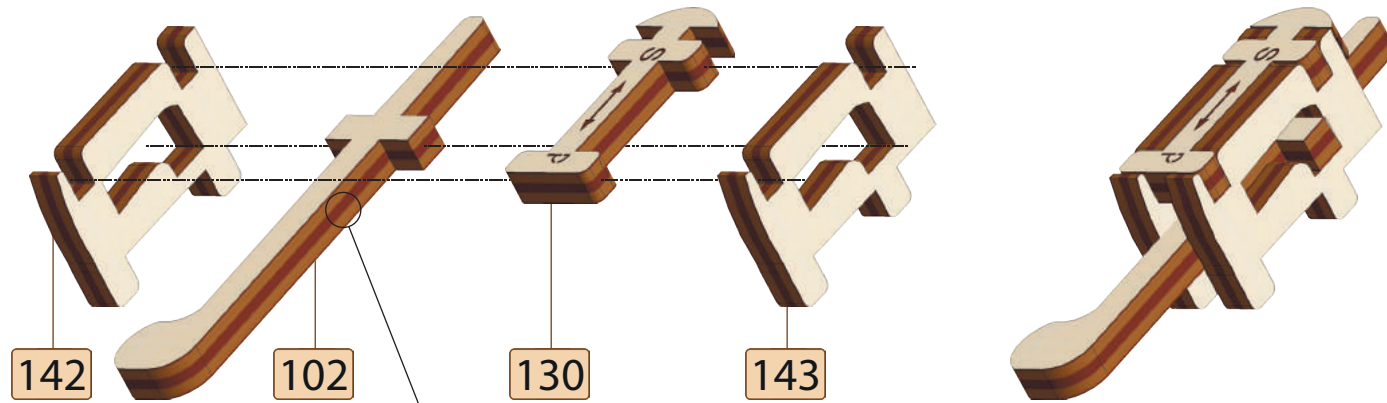
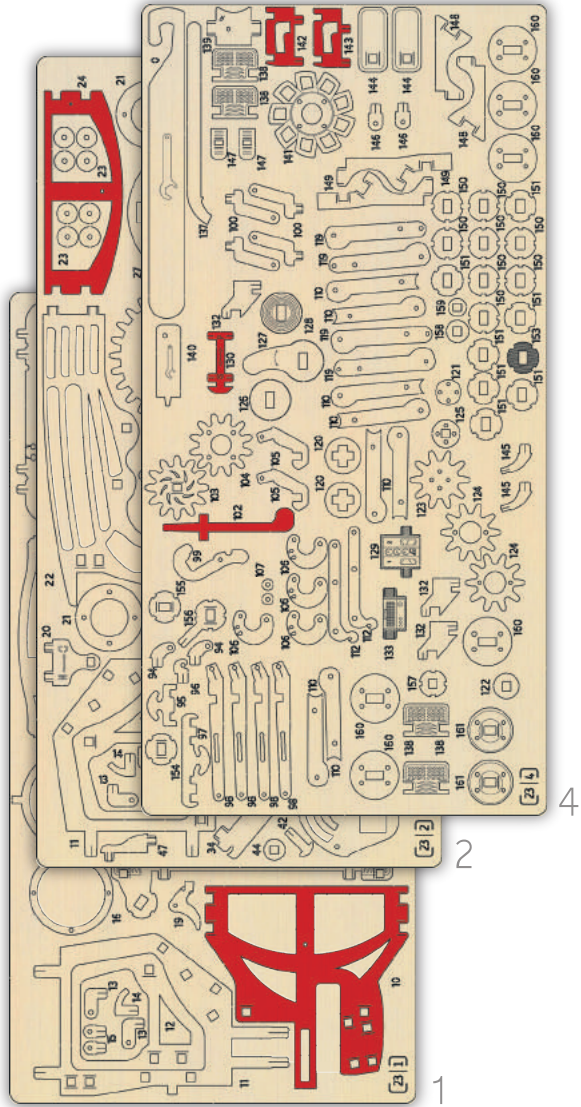

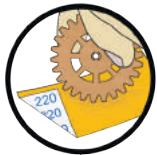
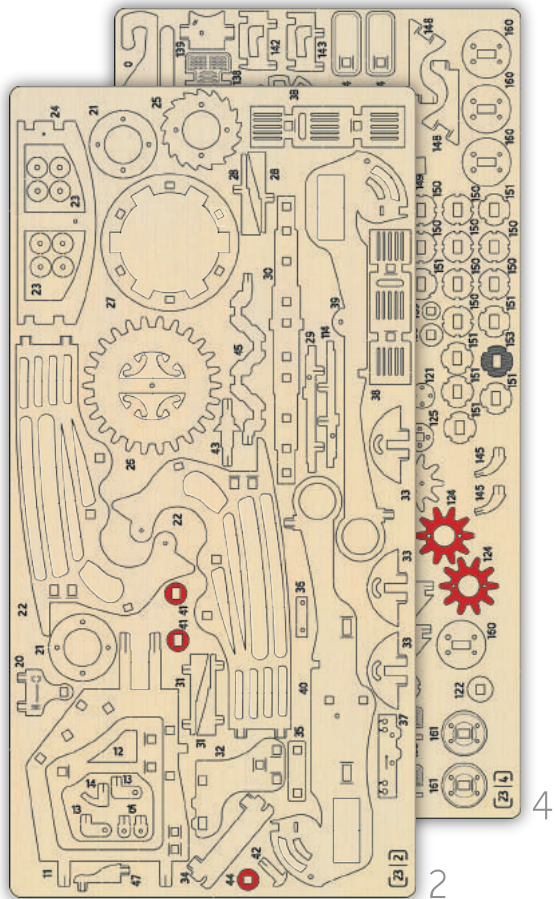

124

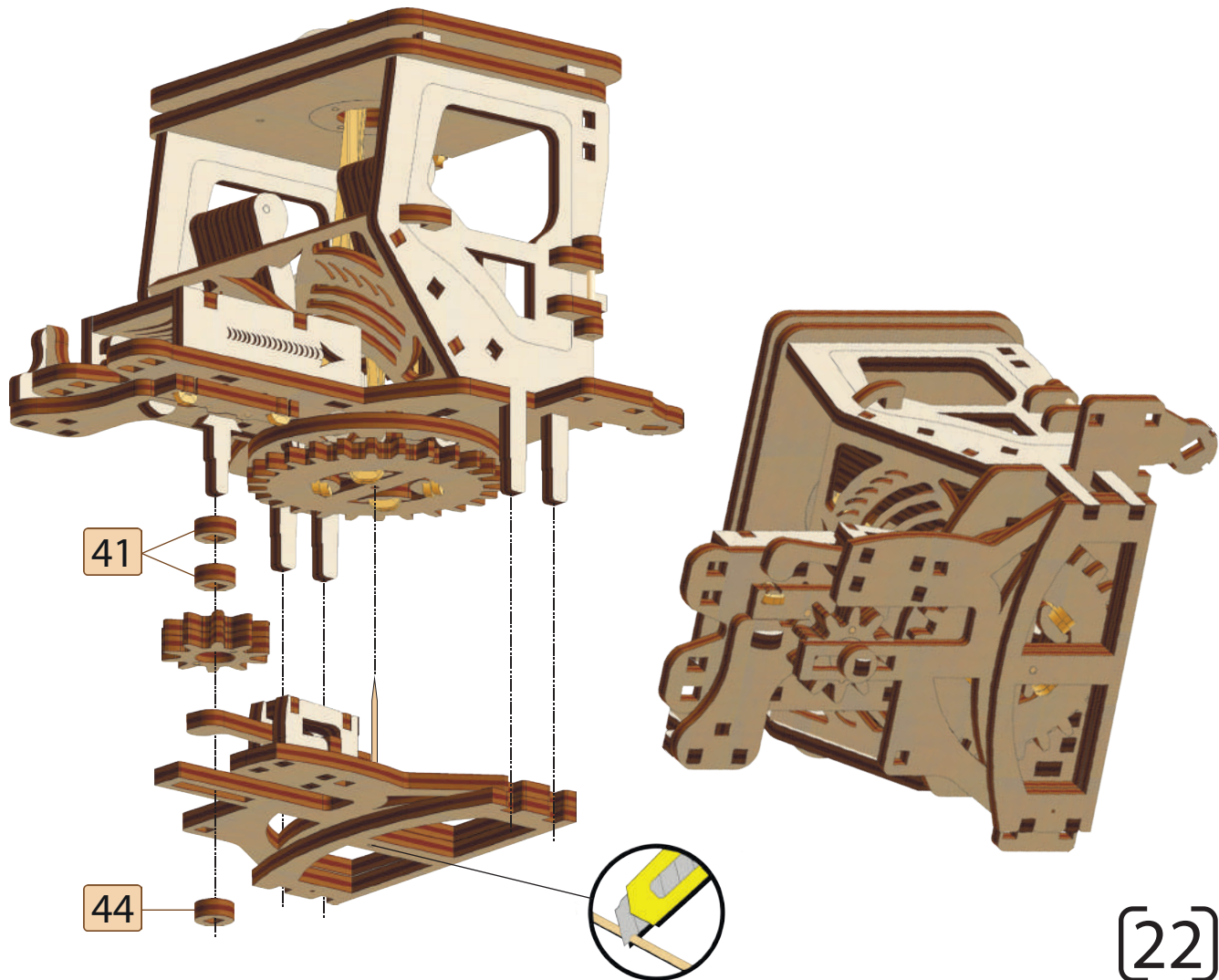
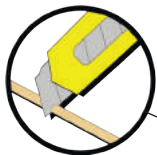
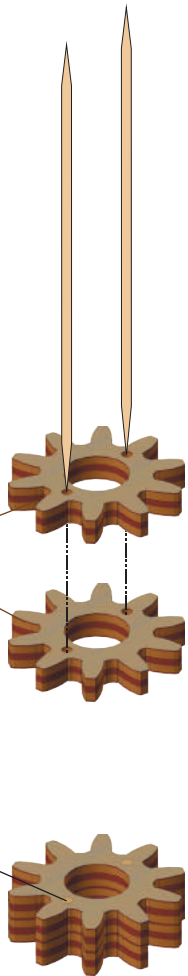

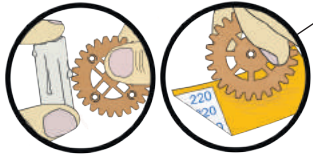
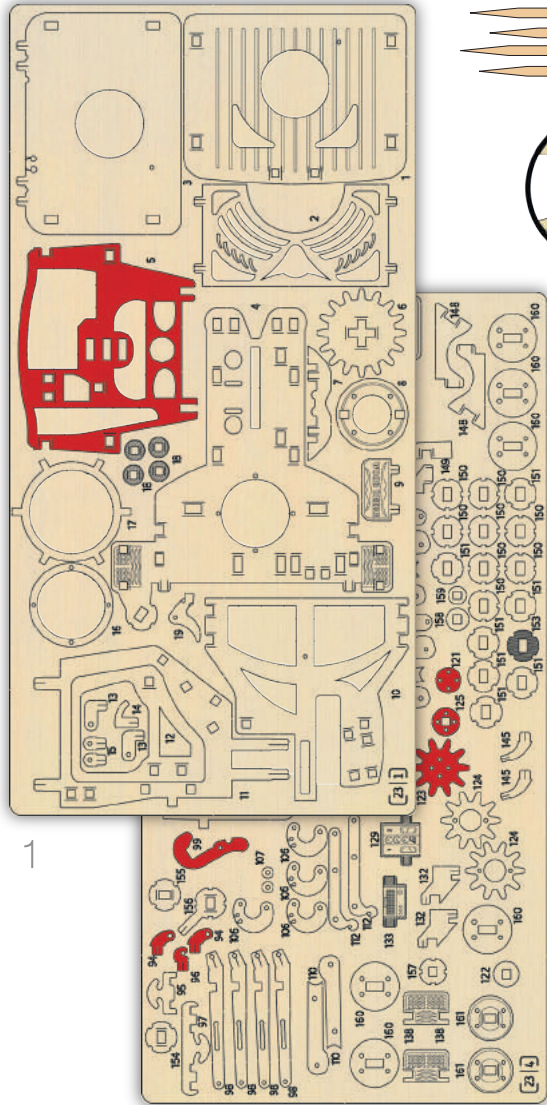

121

125

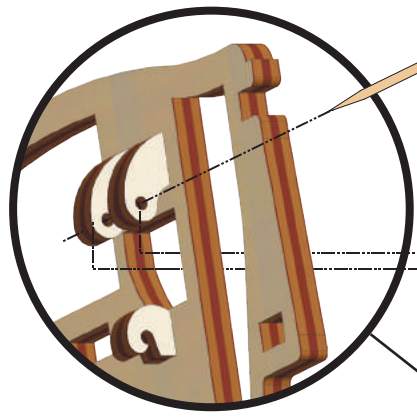
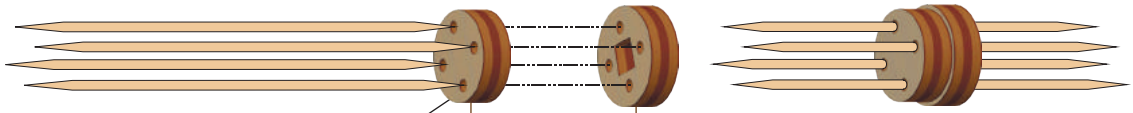

99

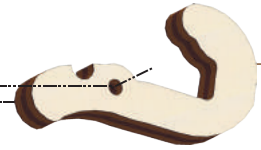

94

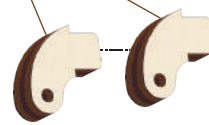

5

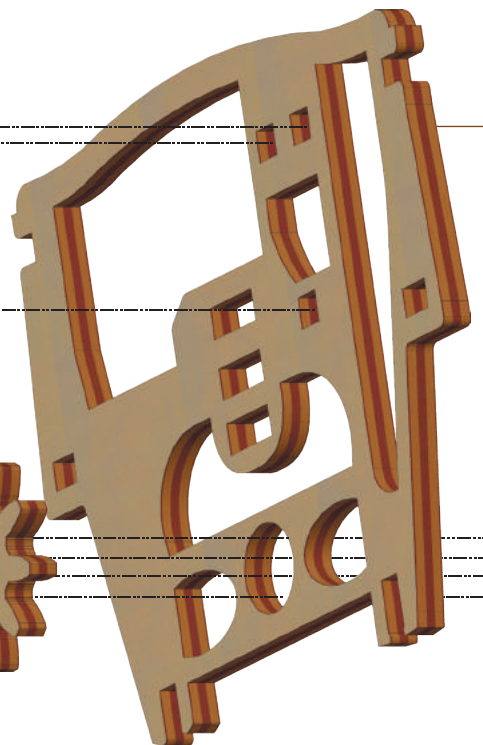

96

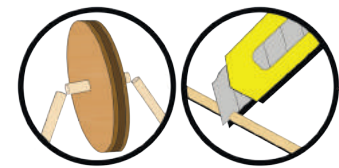

123

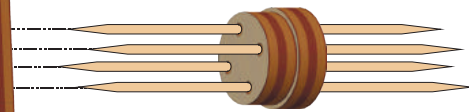
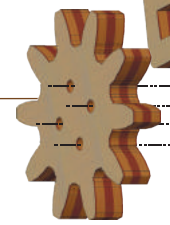
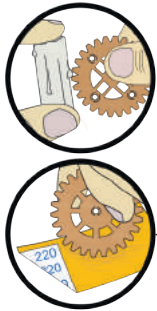

[23]

4



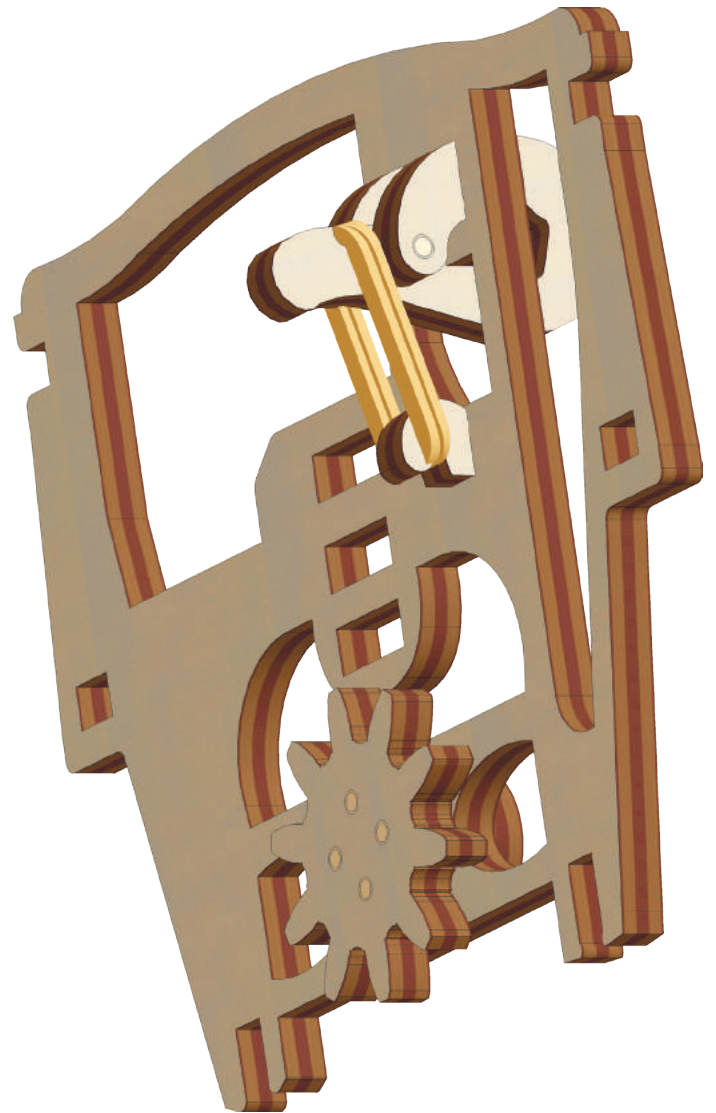
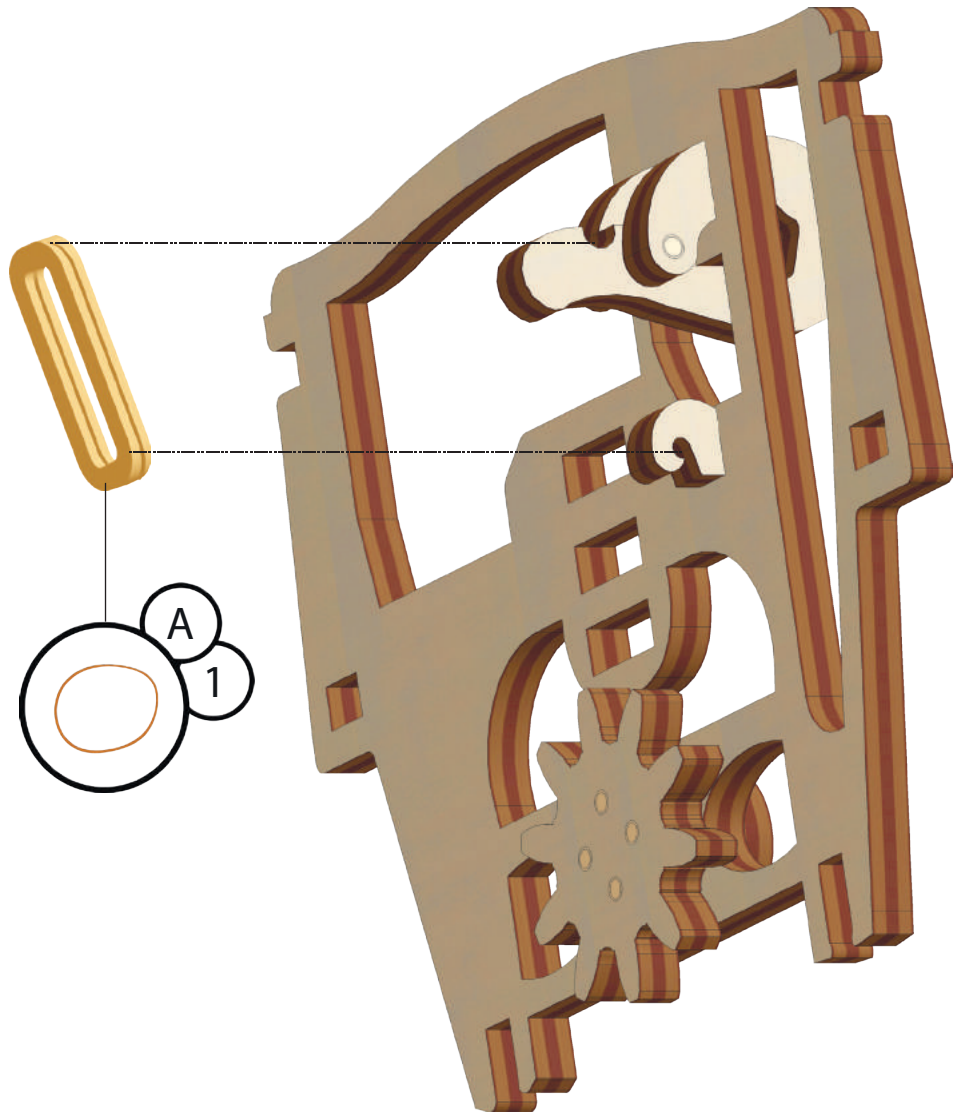

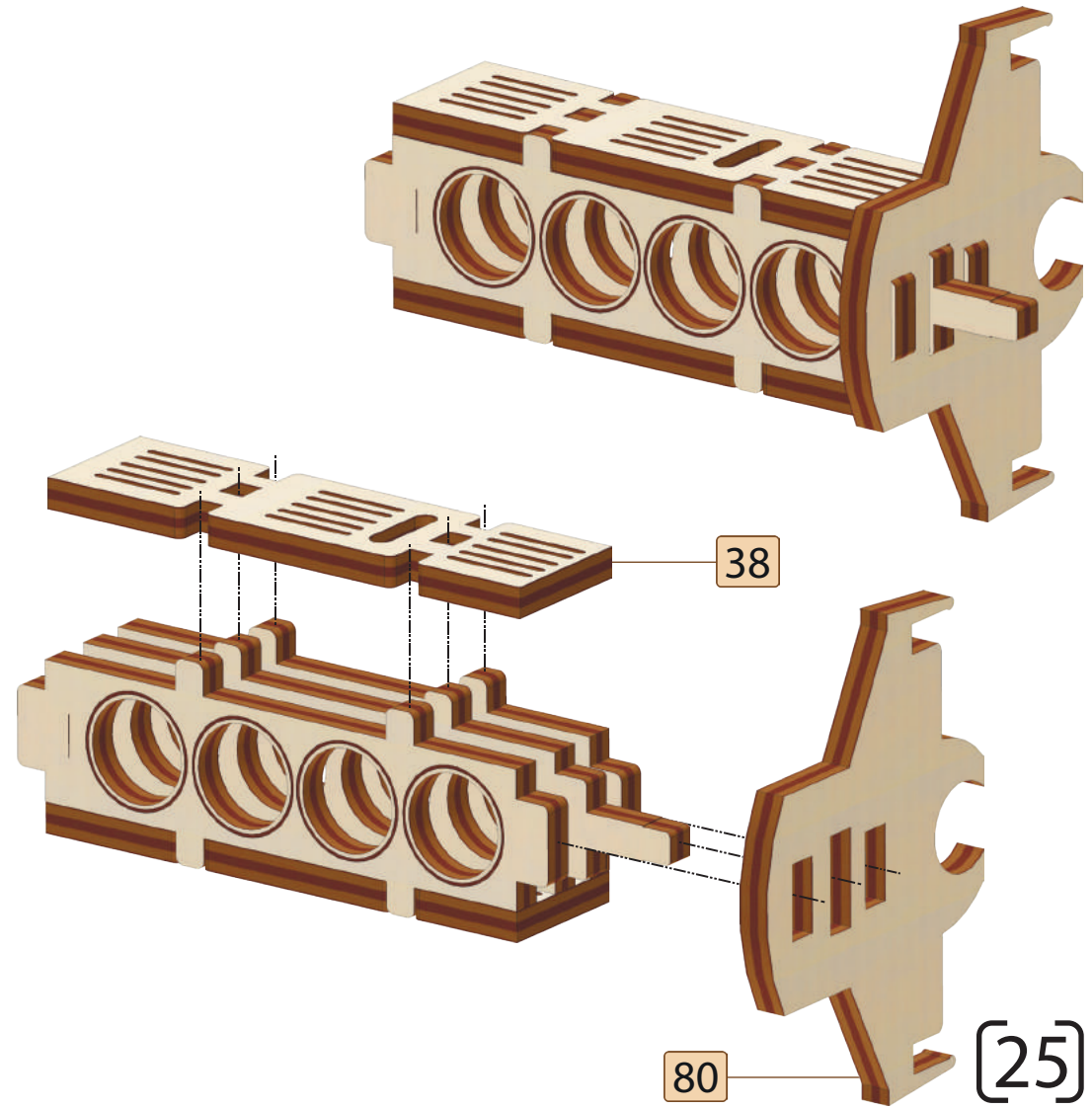
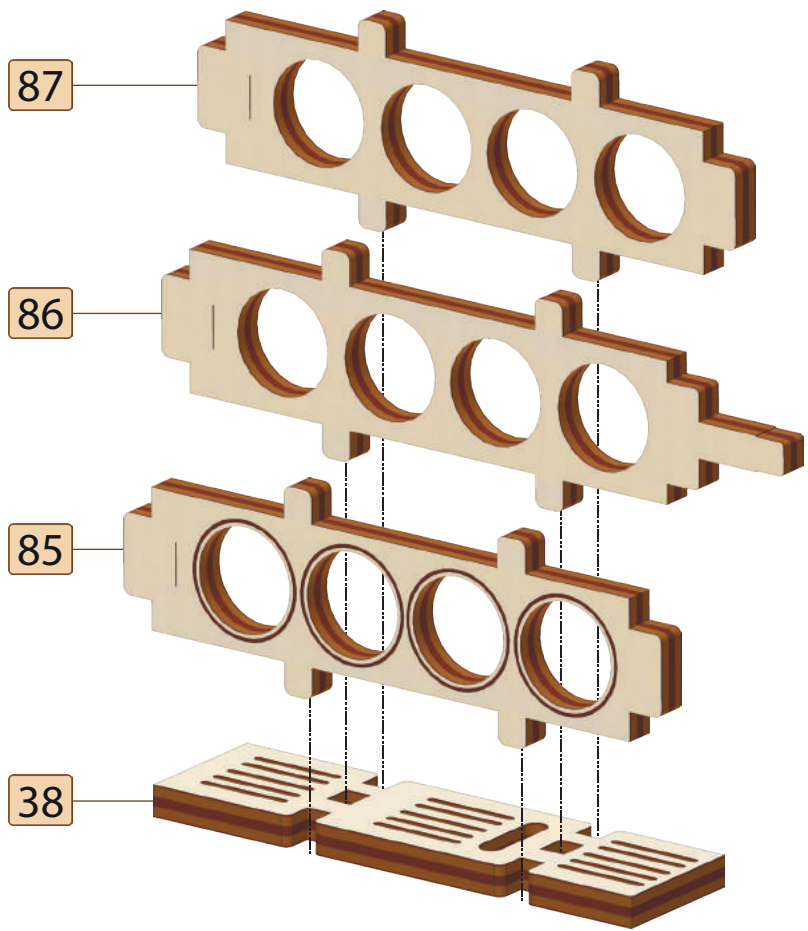
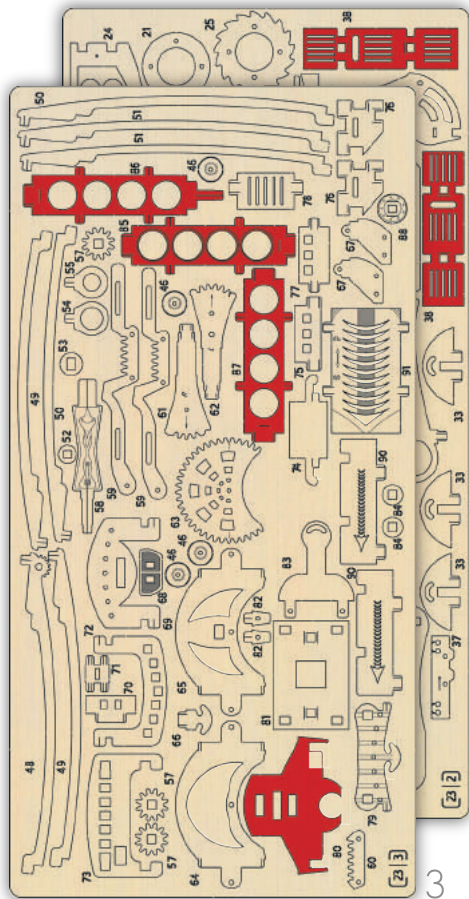

[25]

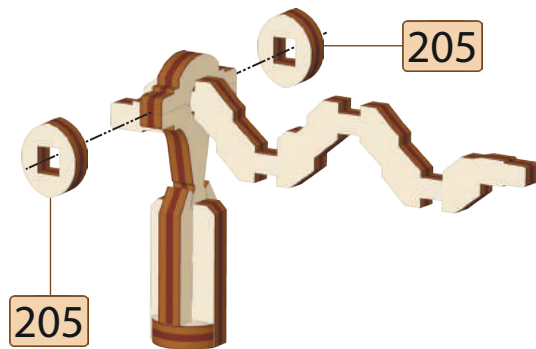
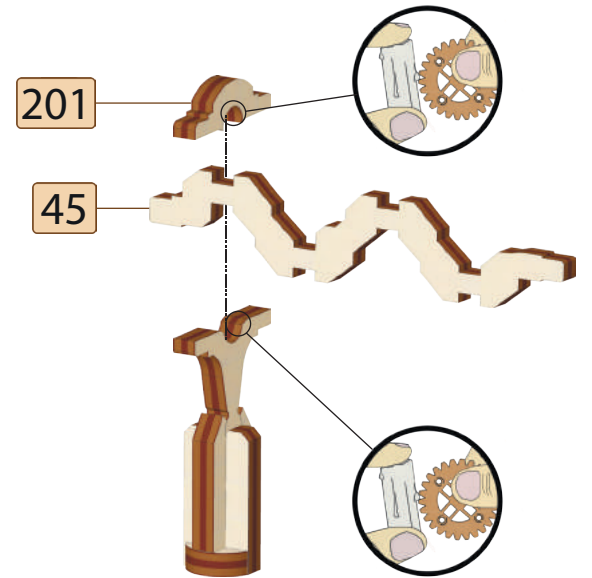
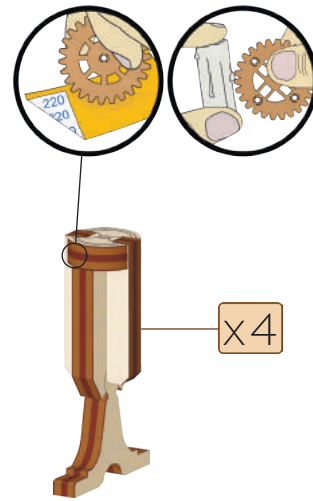
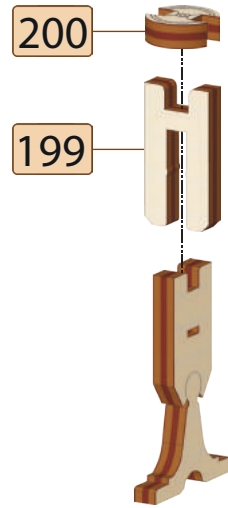
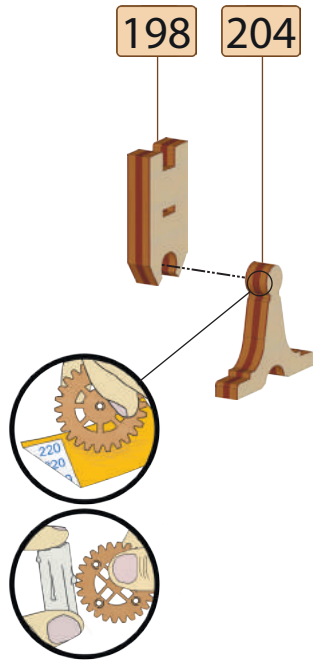
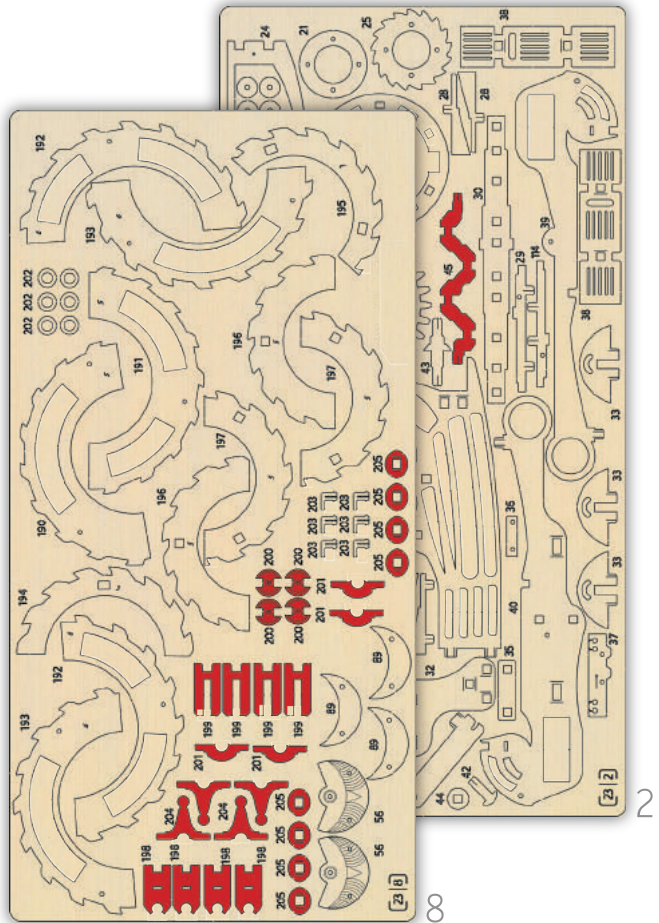

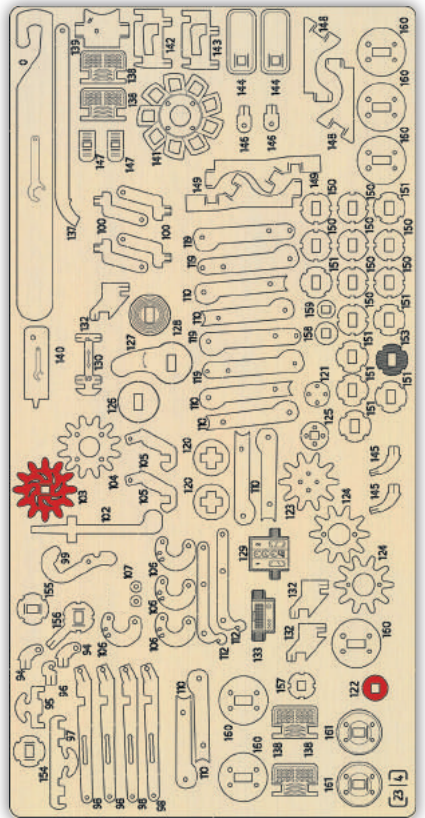

4

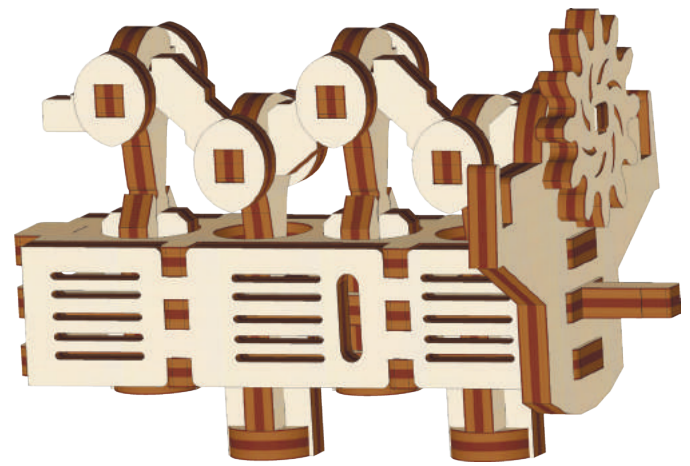
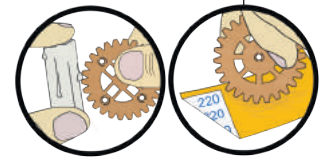
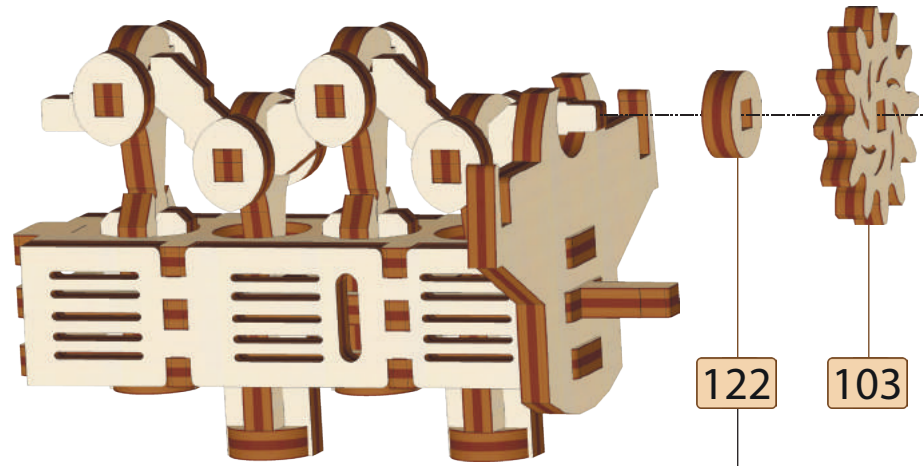
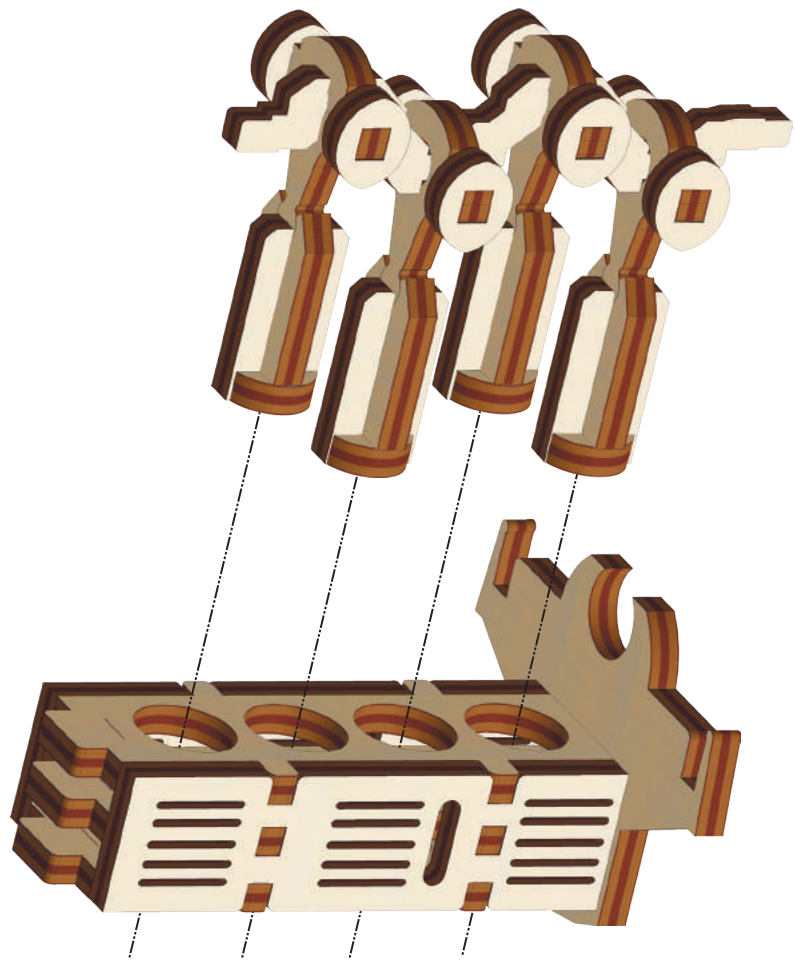

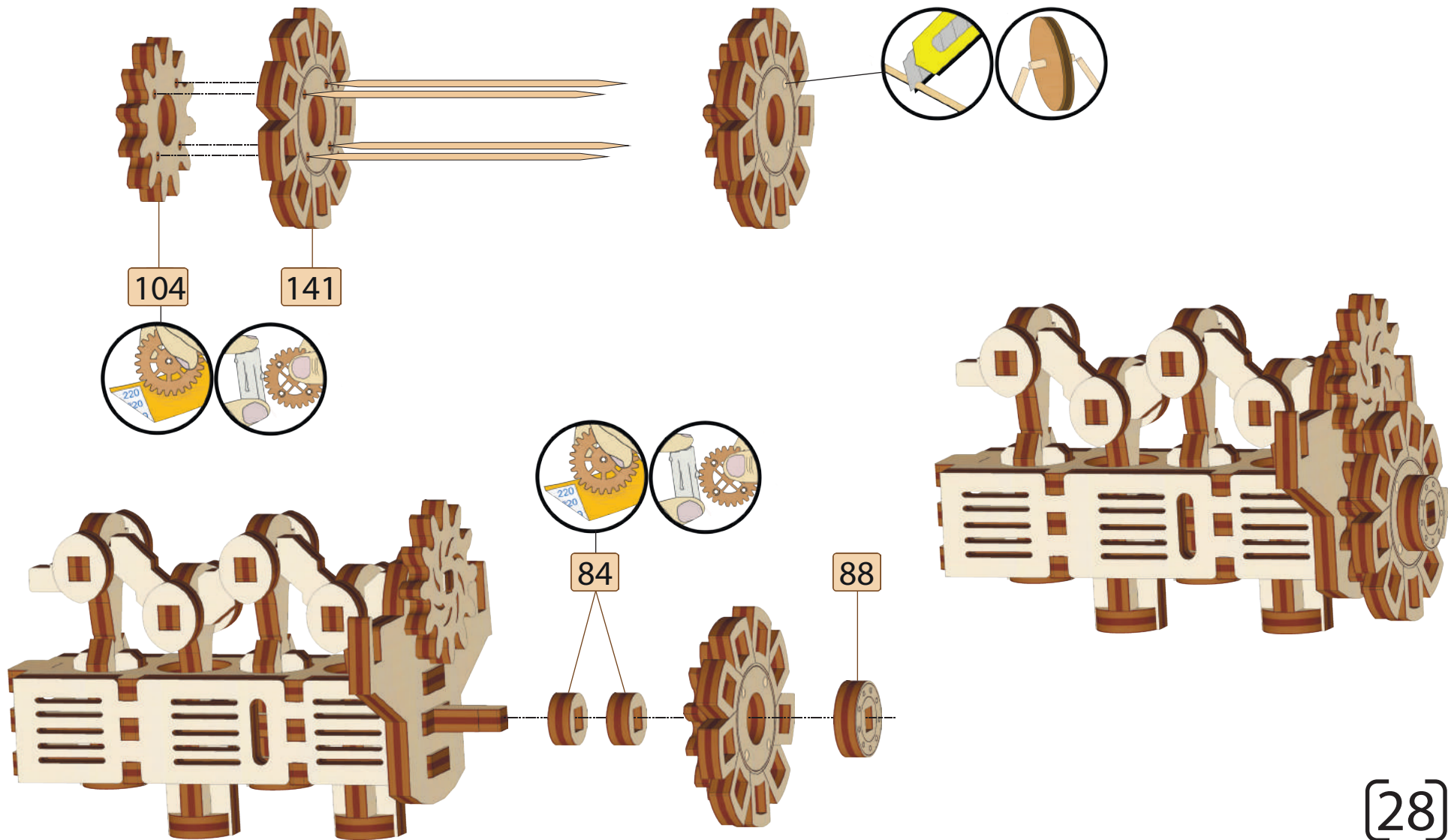
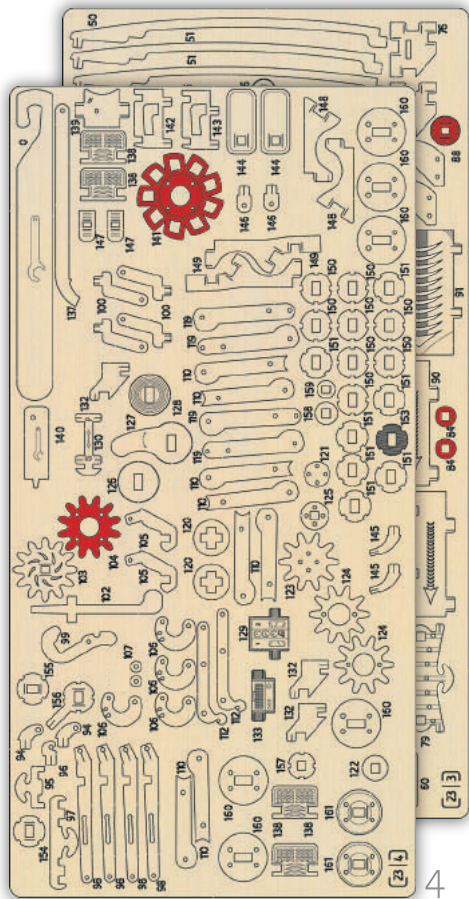

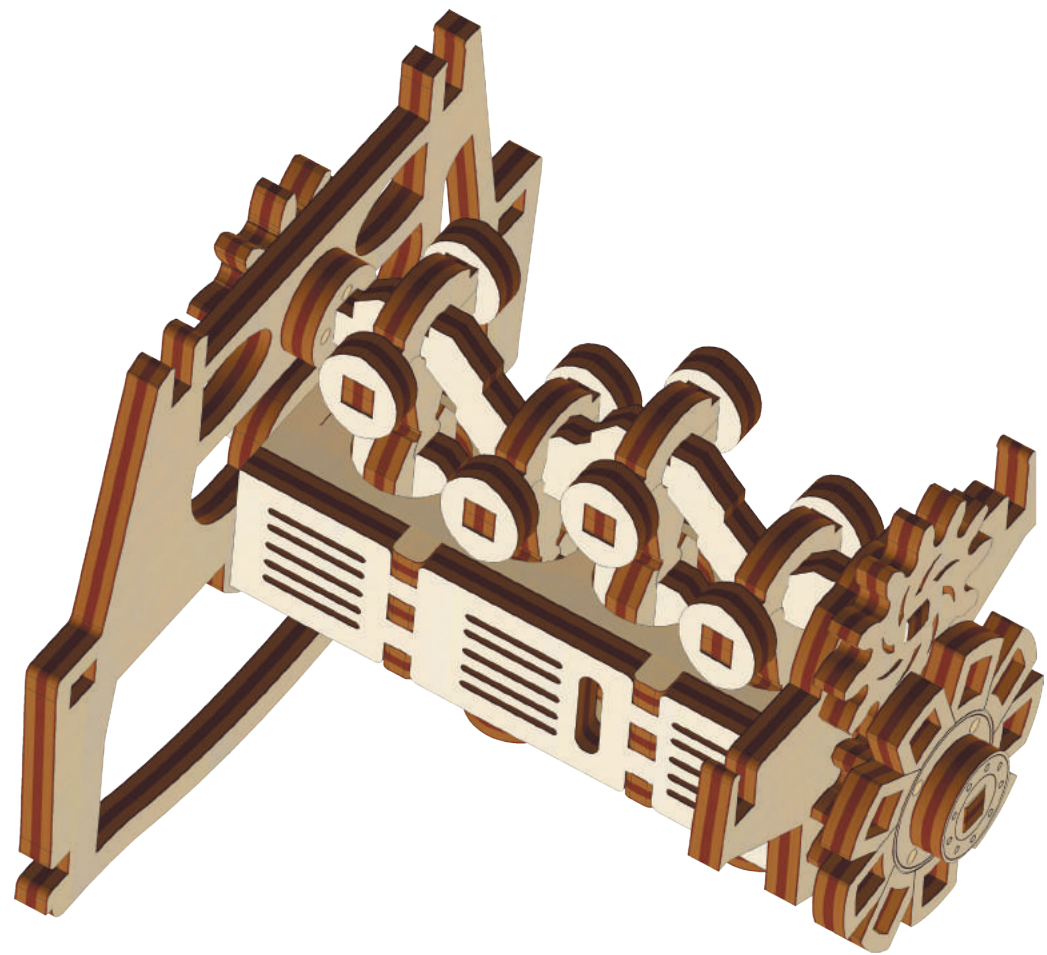
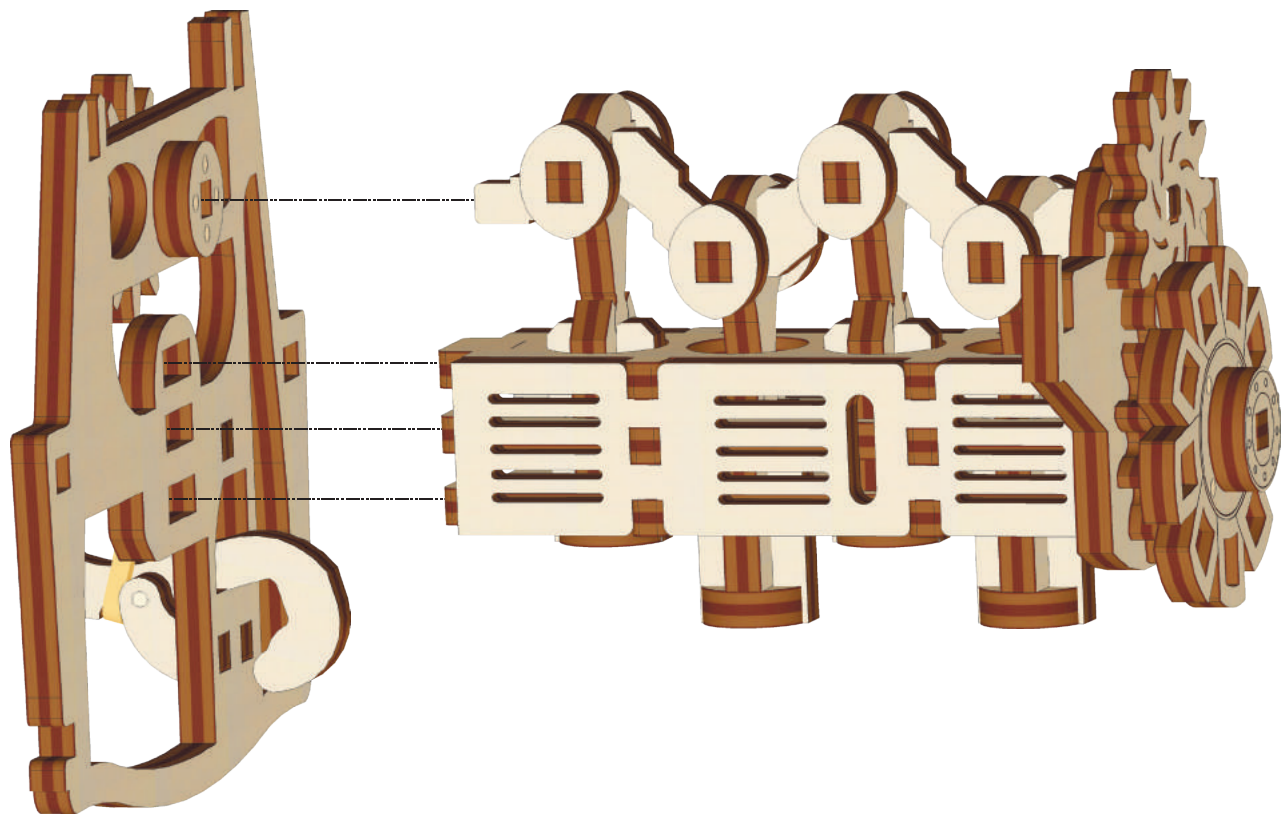

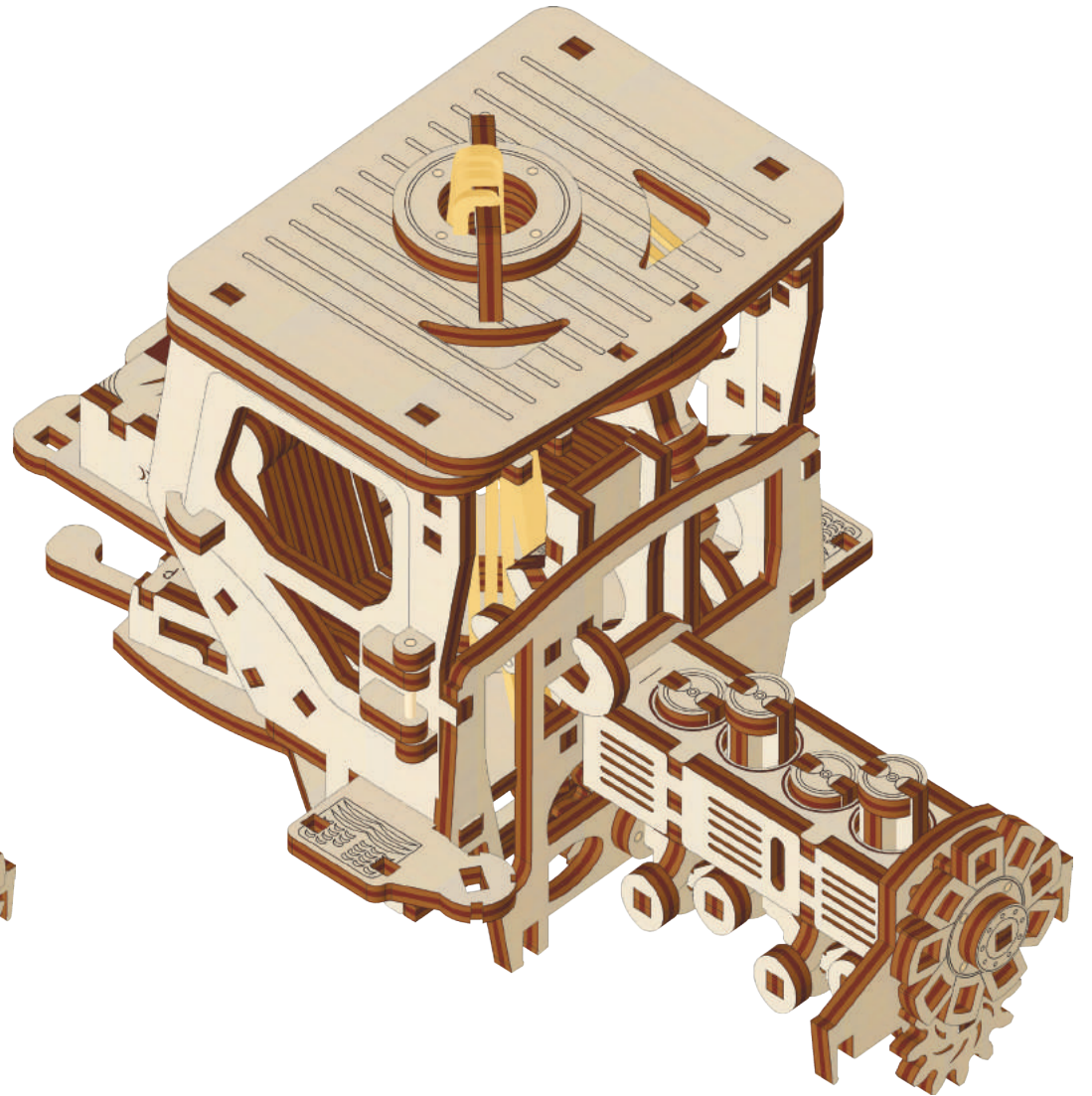
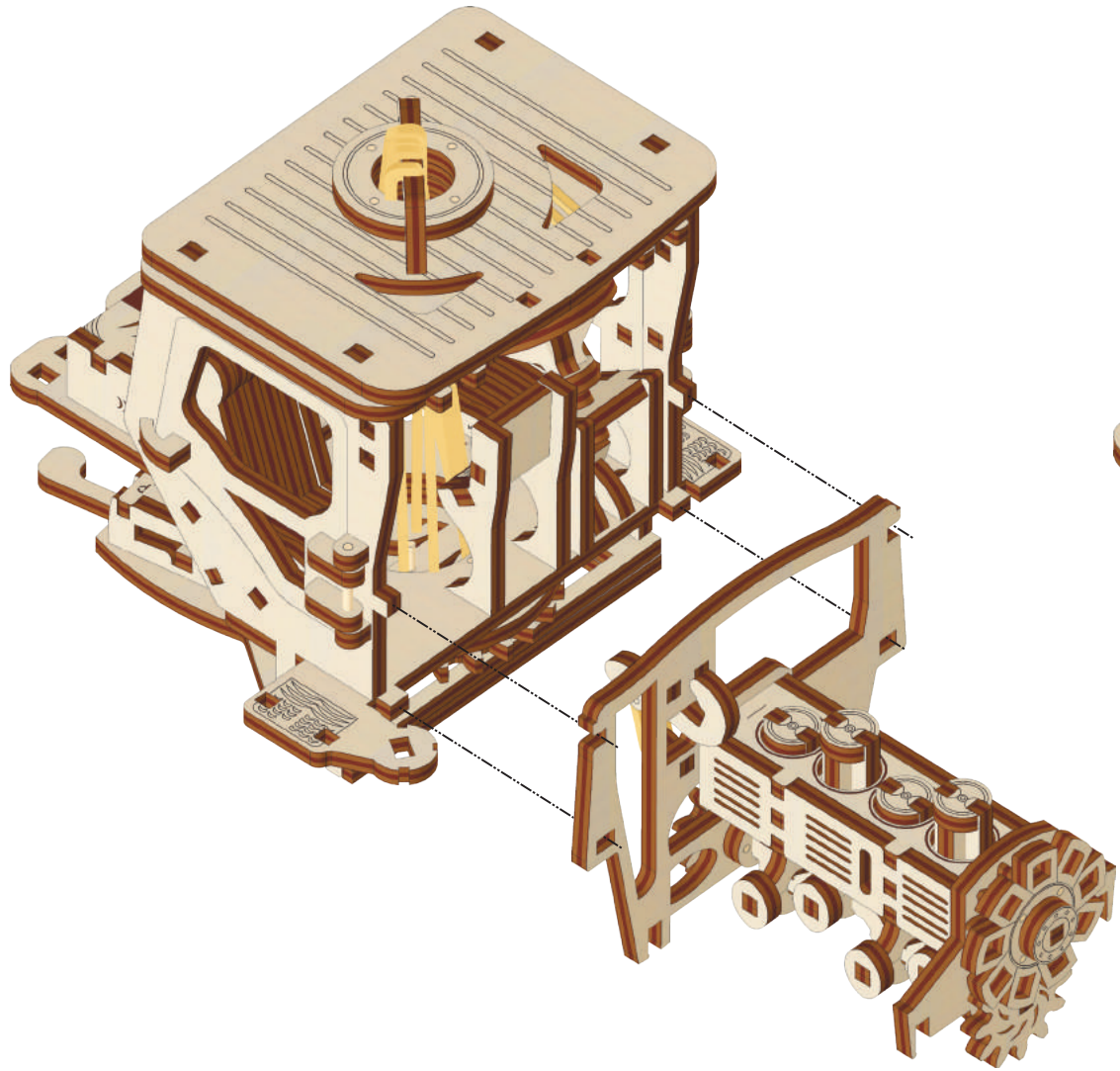

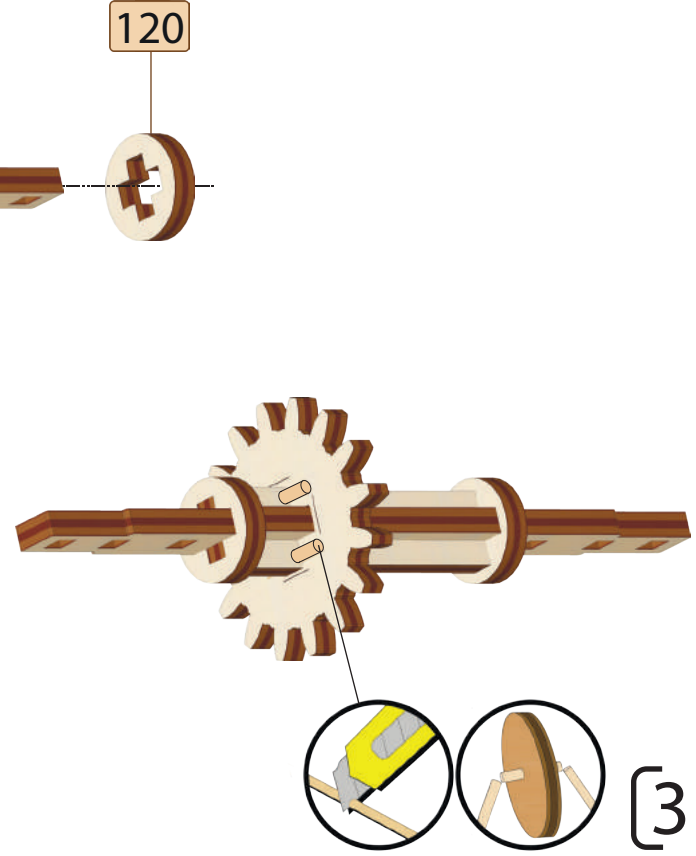
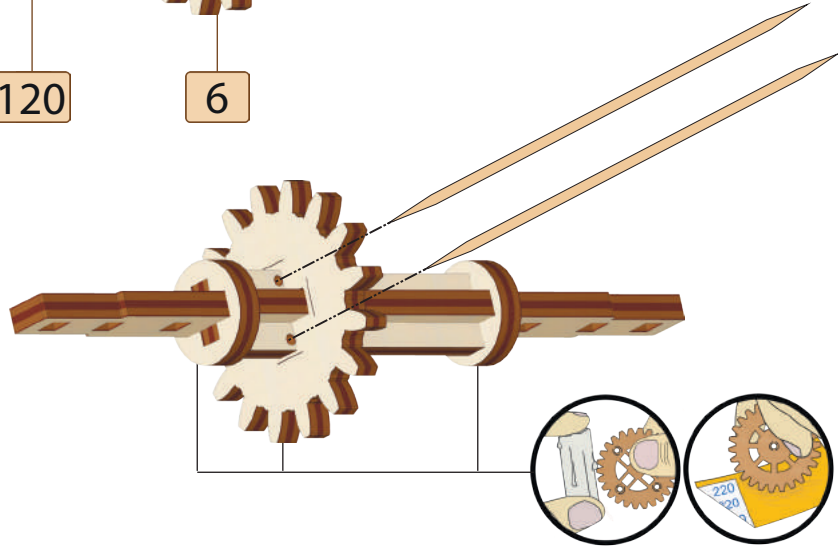
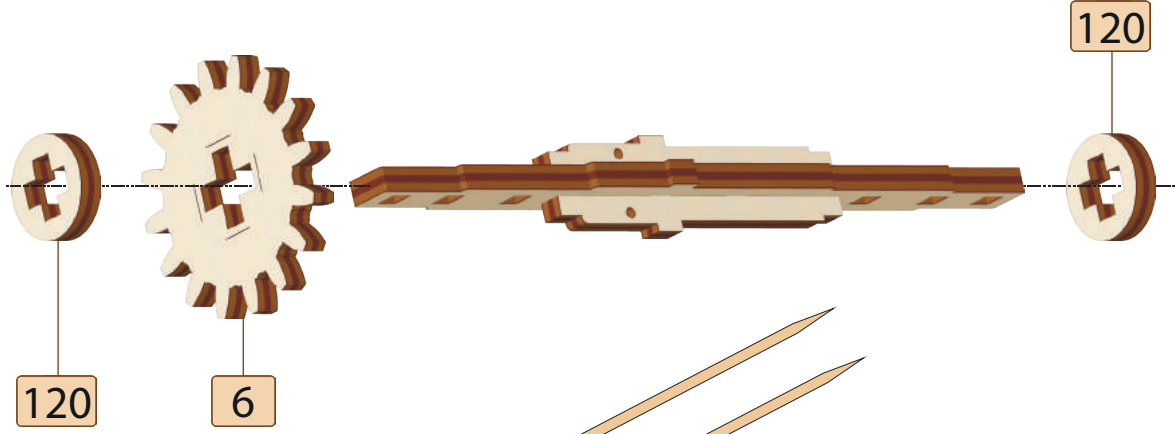
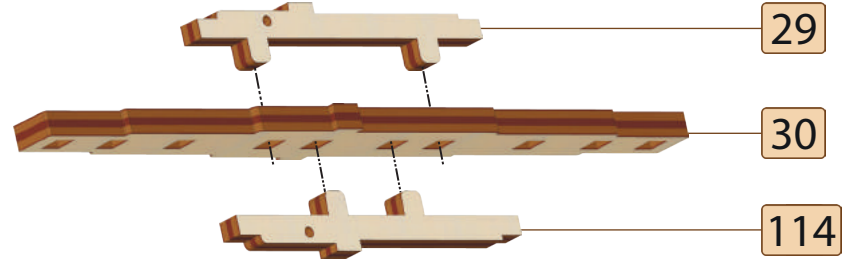
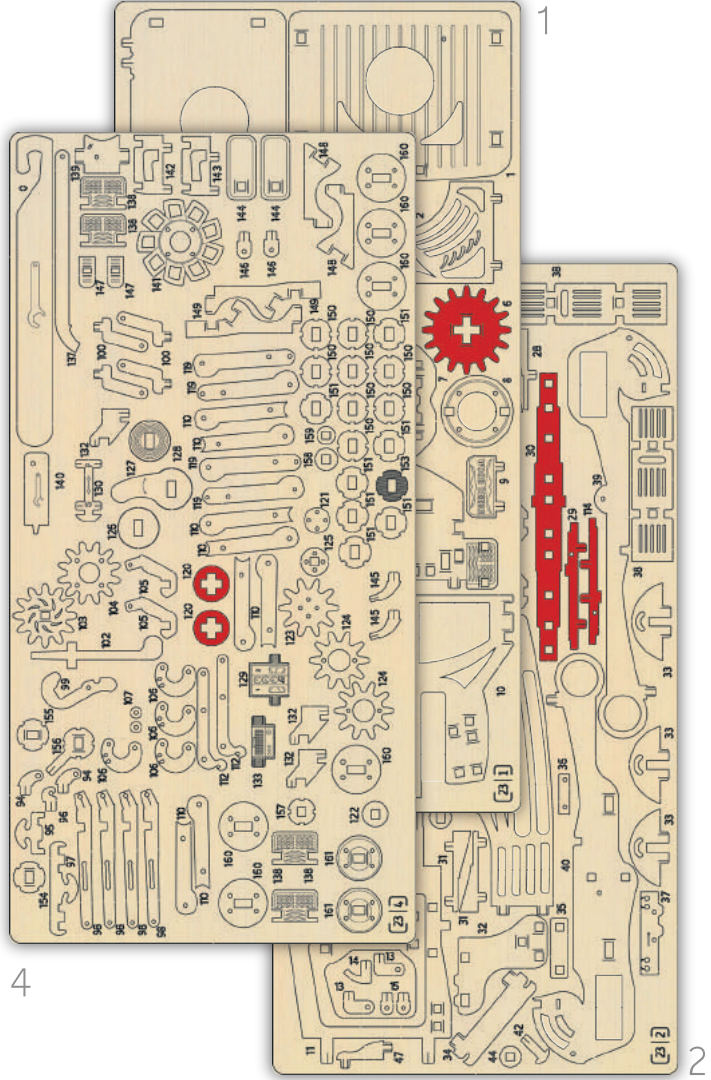

[31]



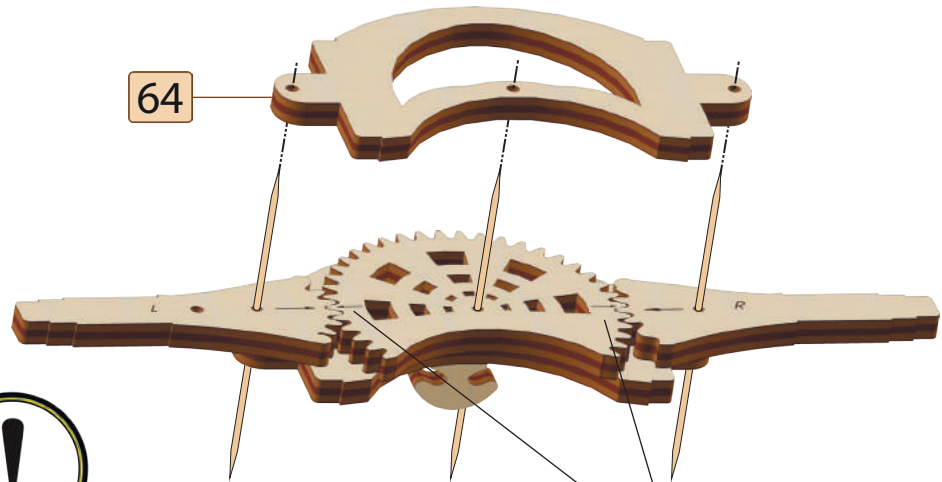
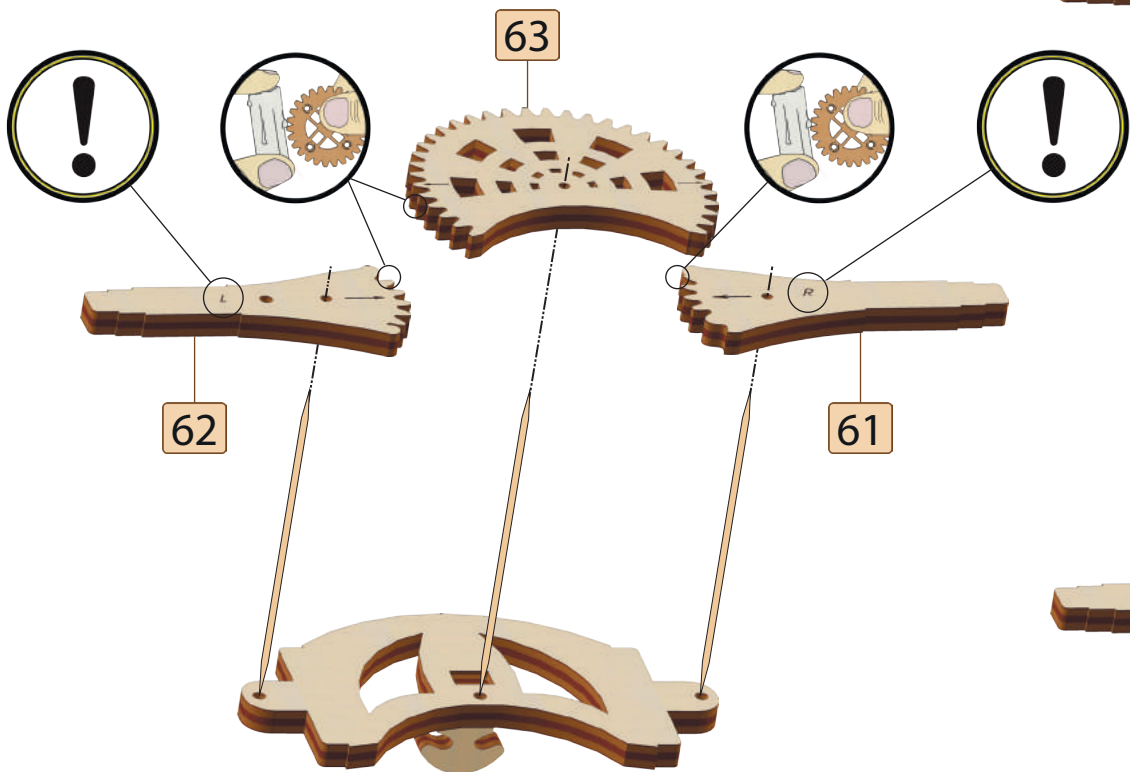
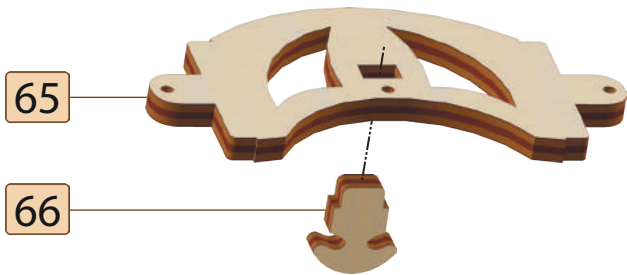
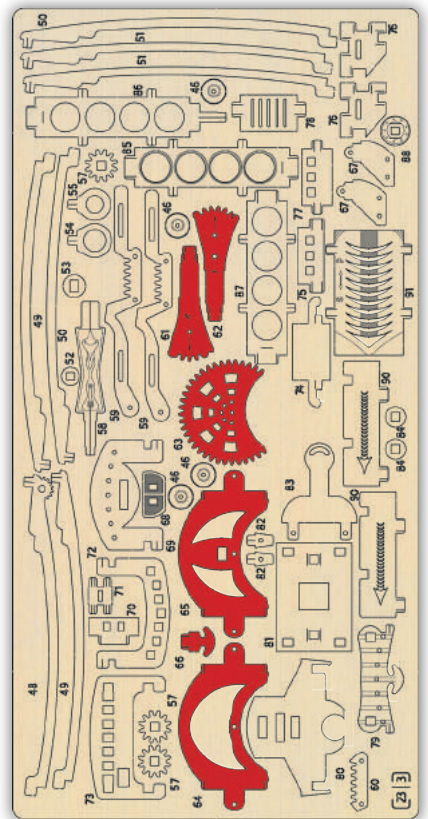

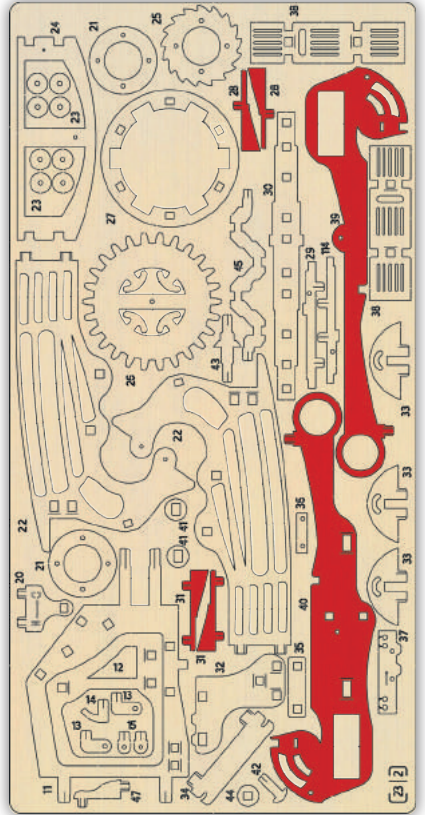

2

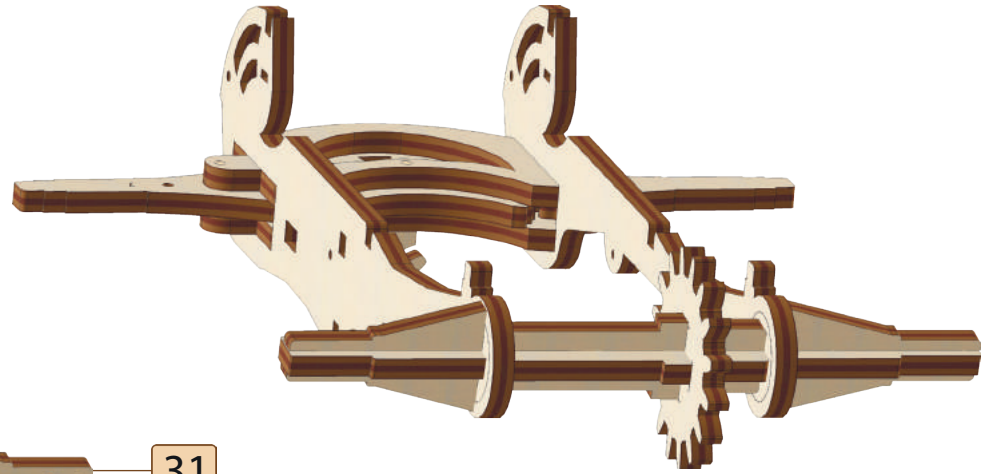
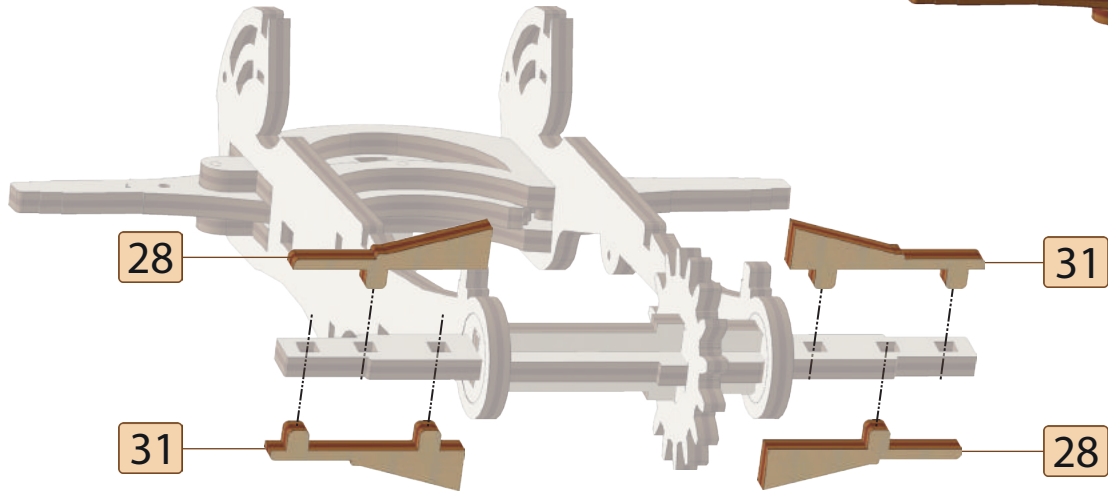
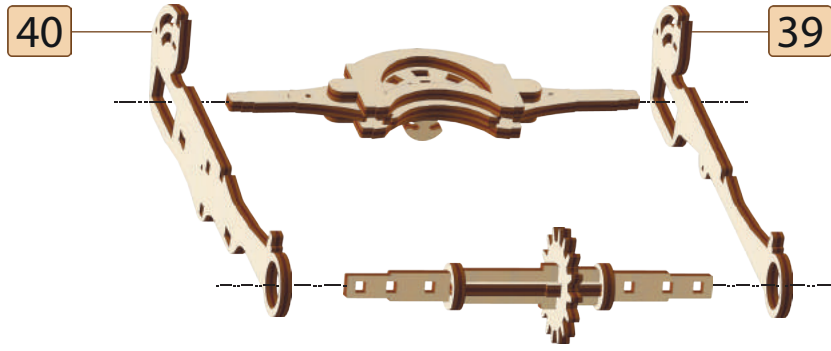

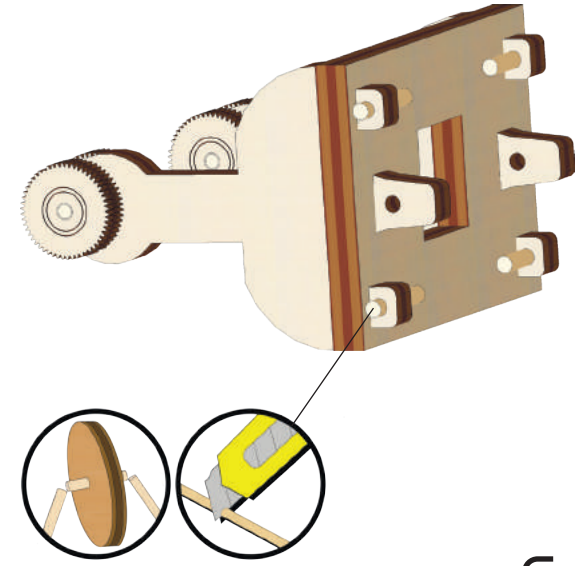
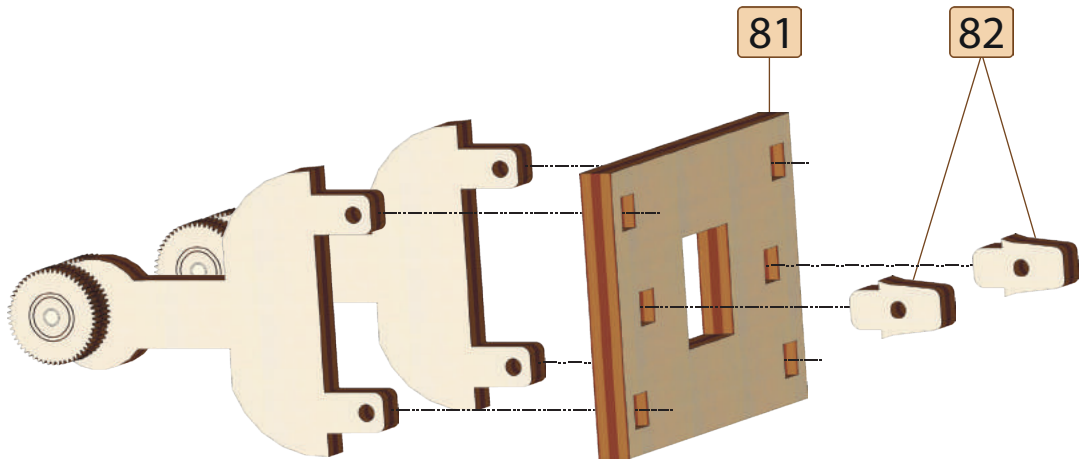
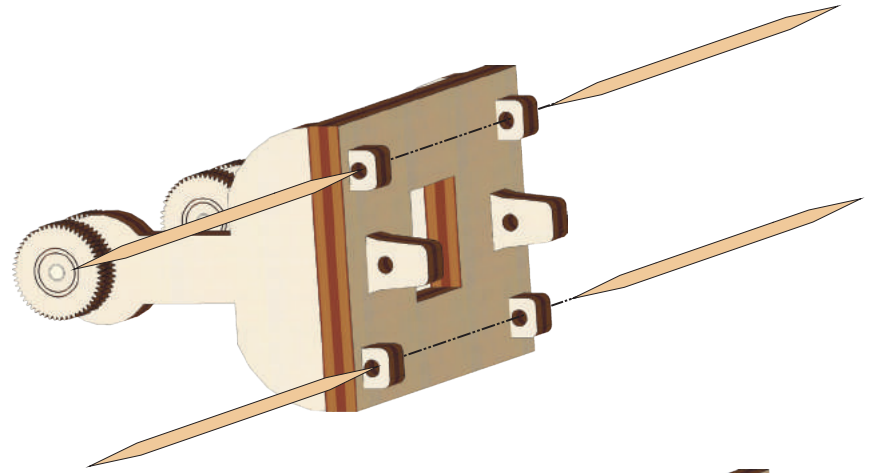
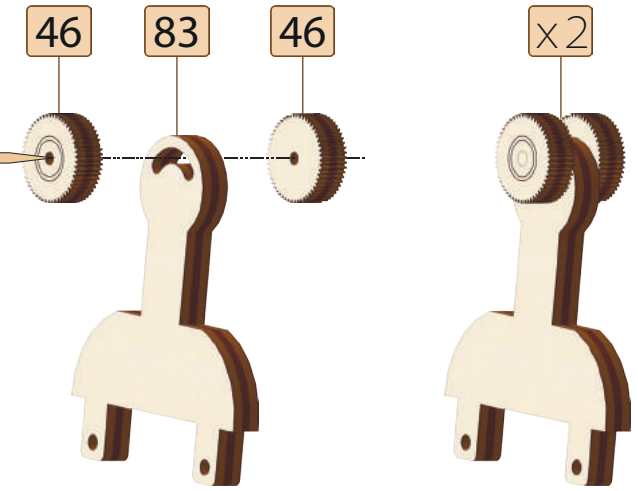
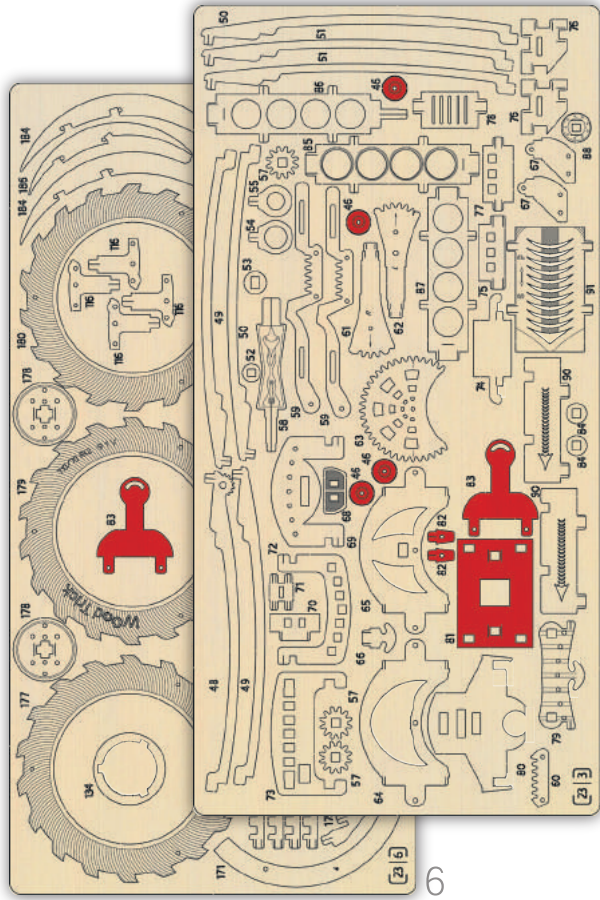

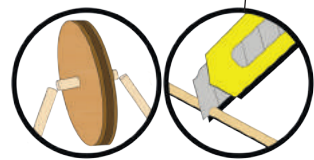
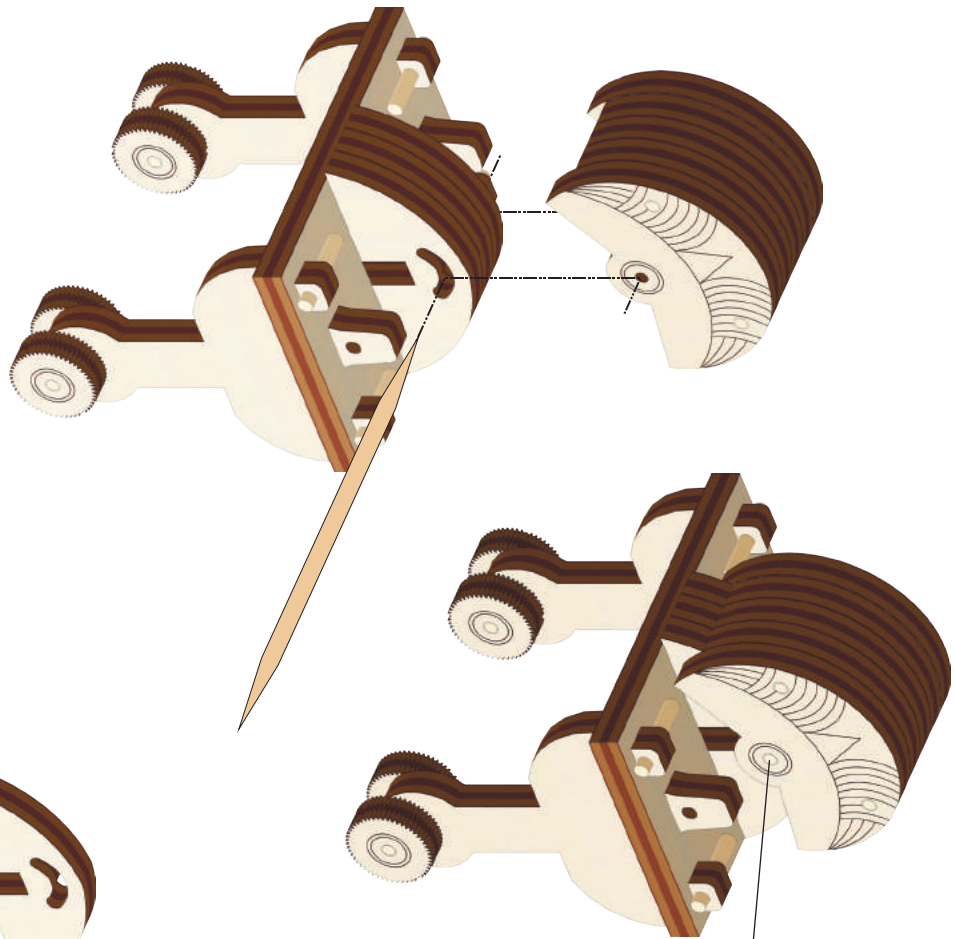
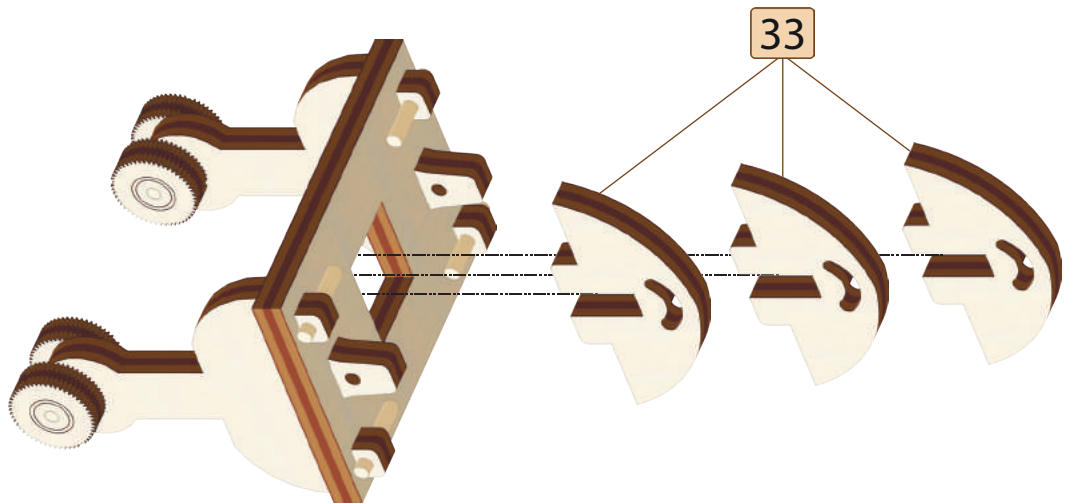
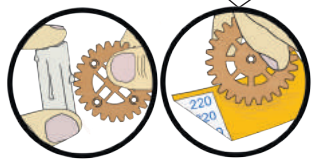
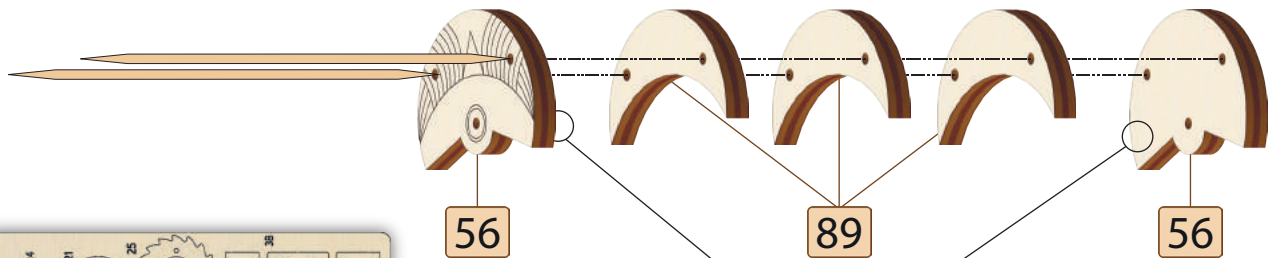
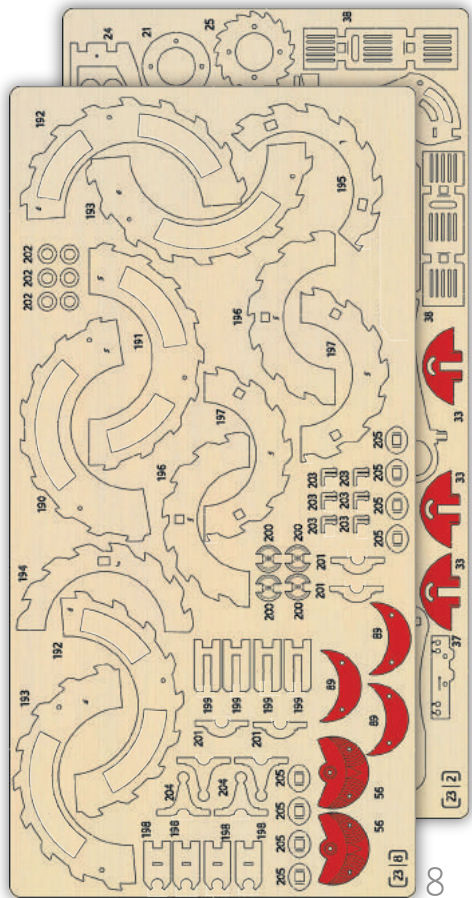

[35]

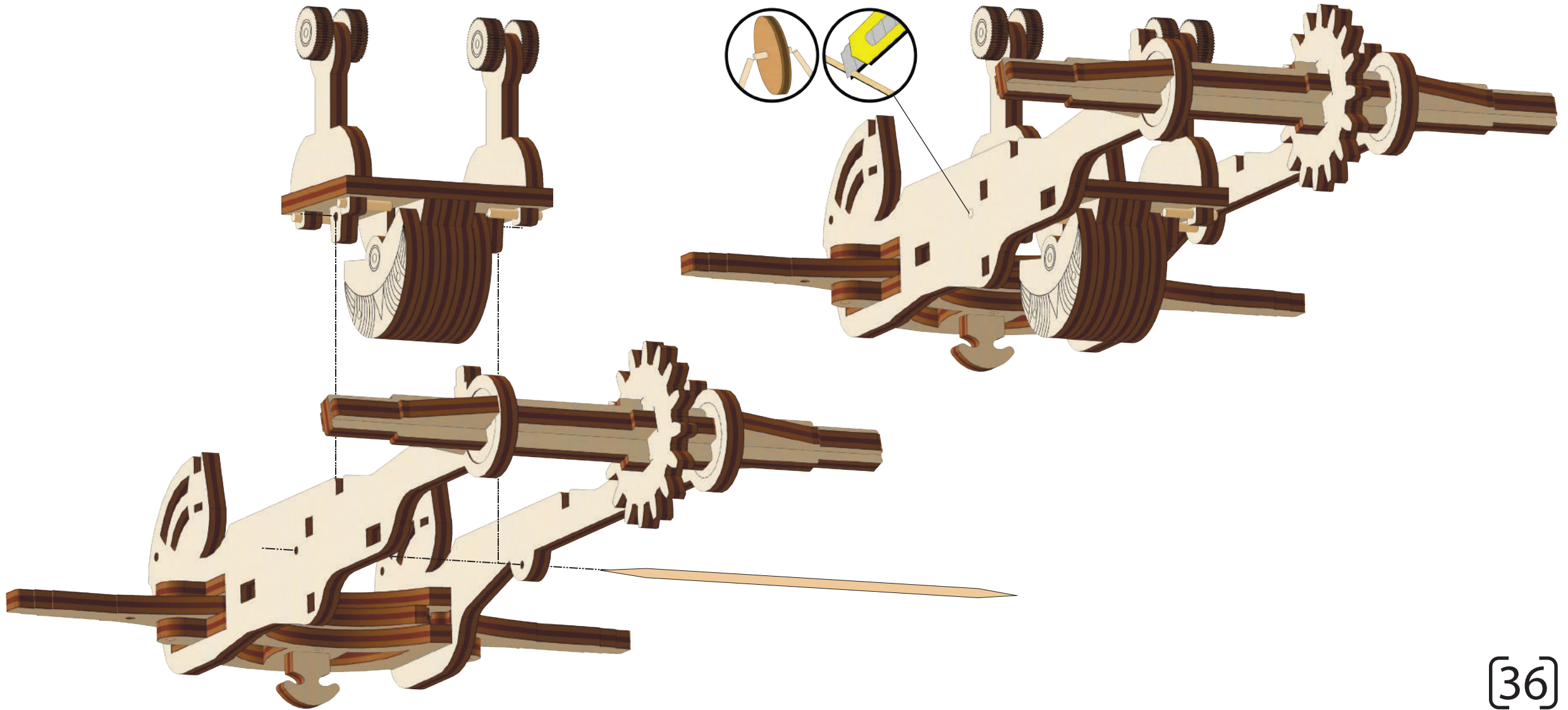

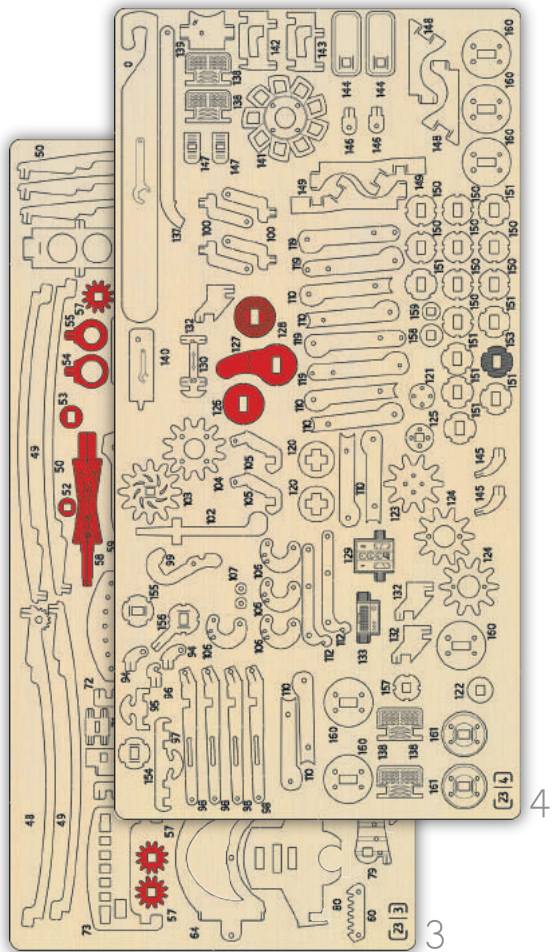

4

3

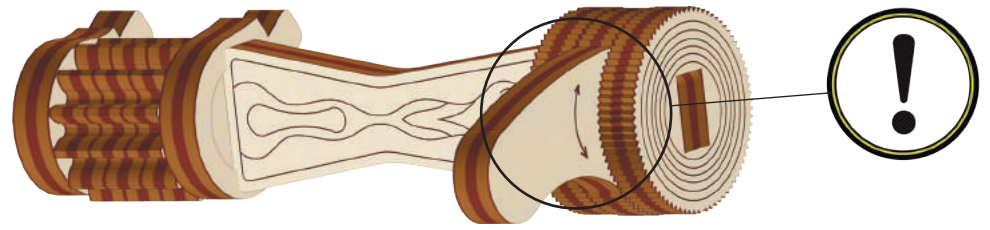
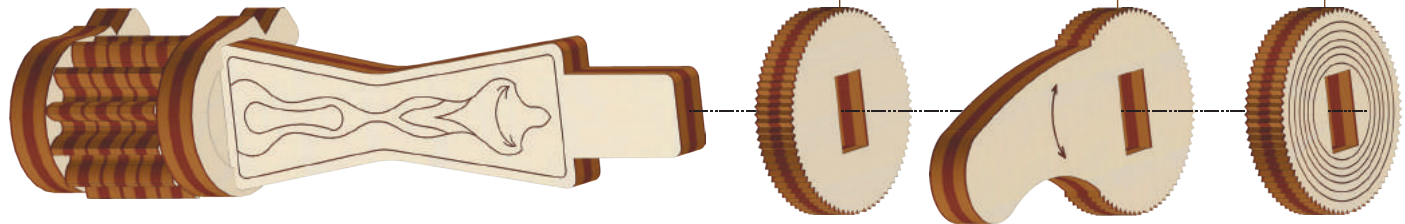
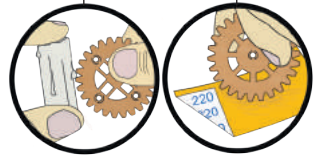
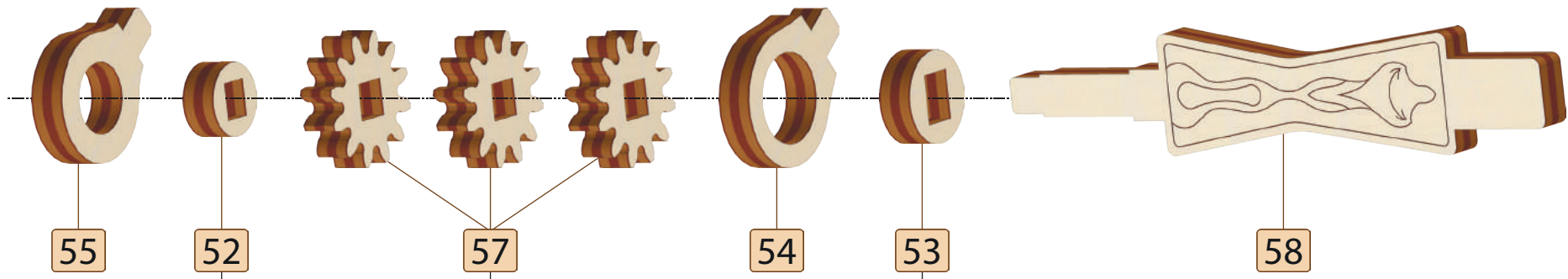

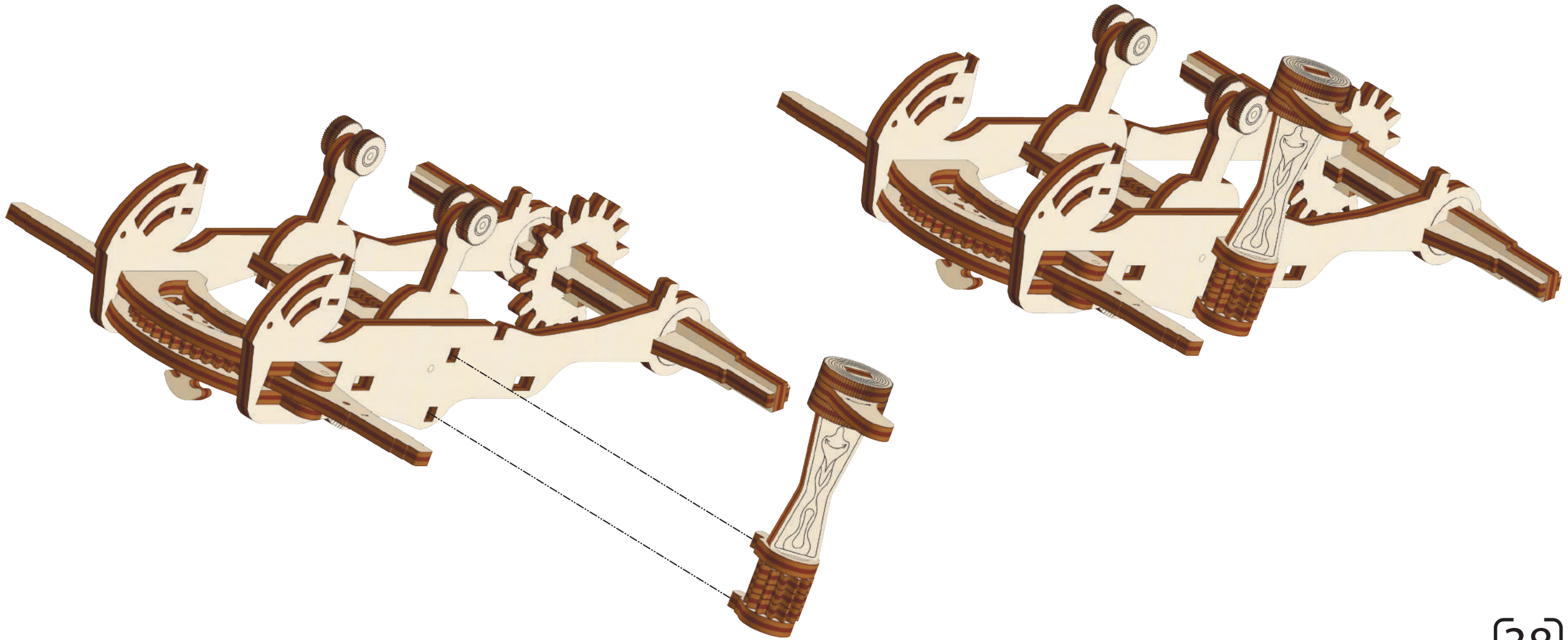

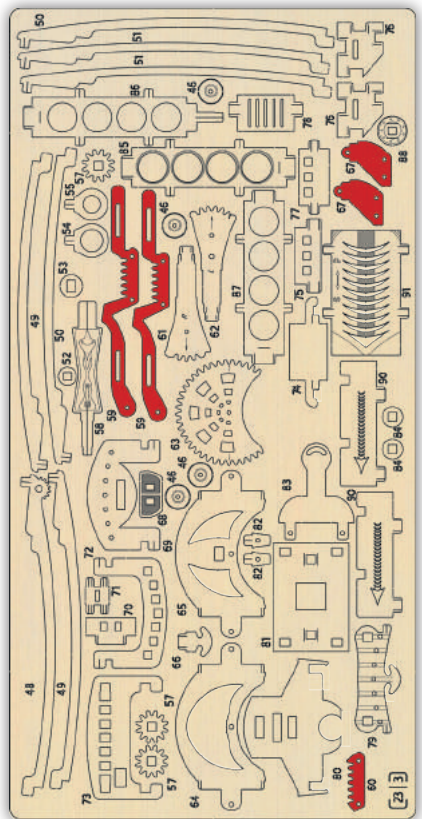

3

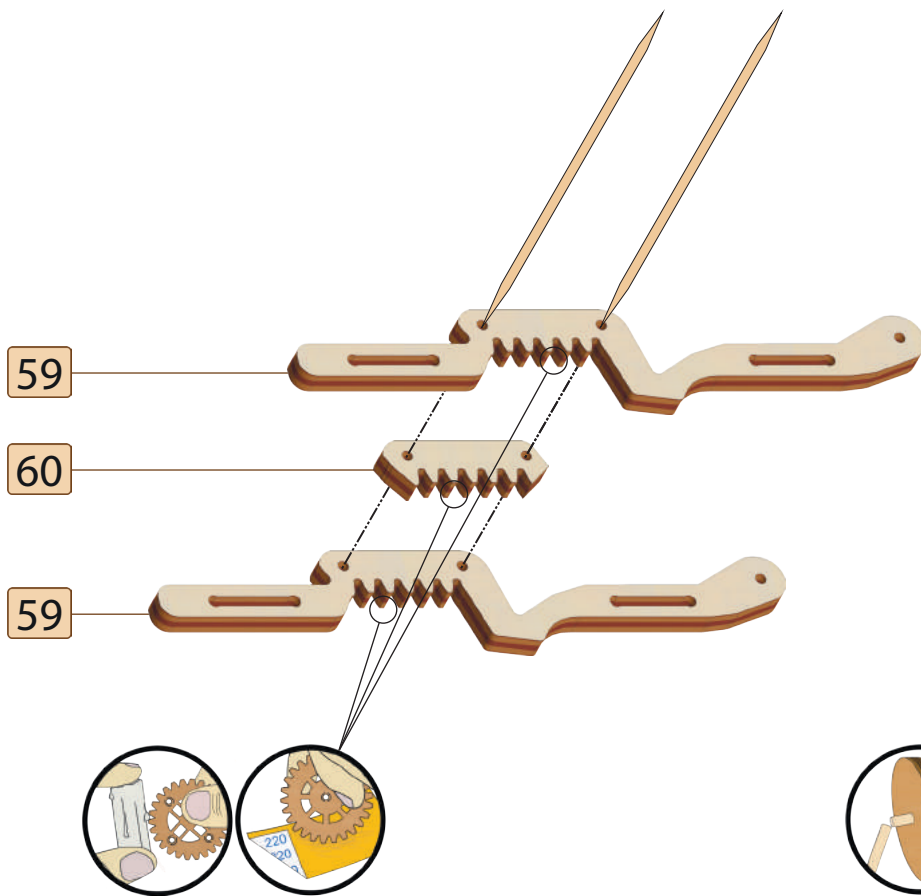

59

60

59

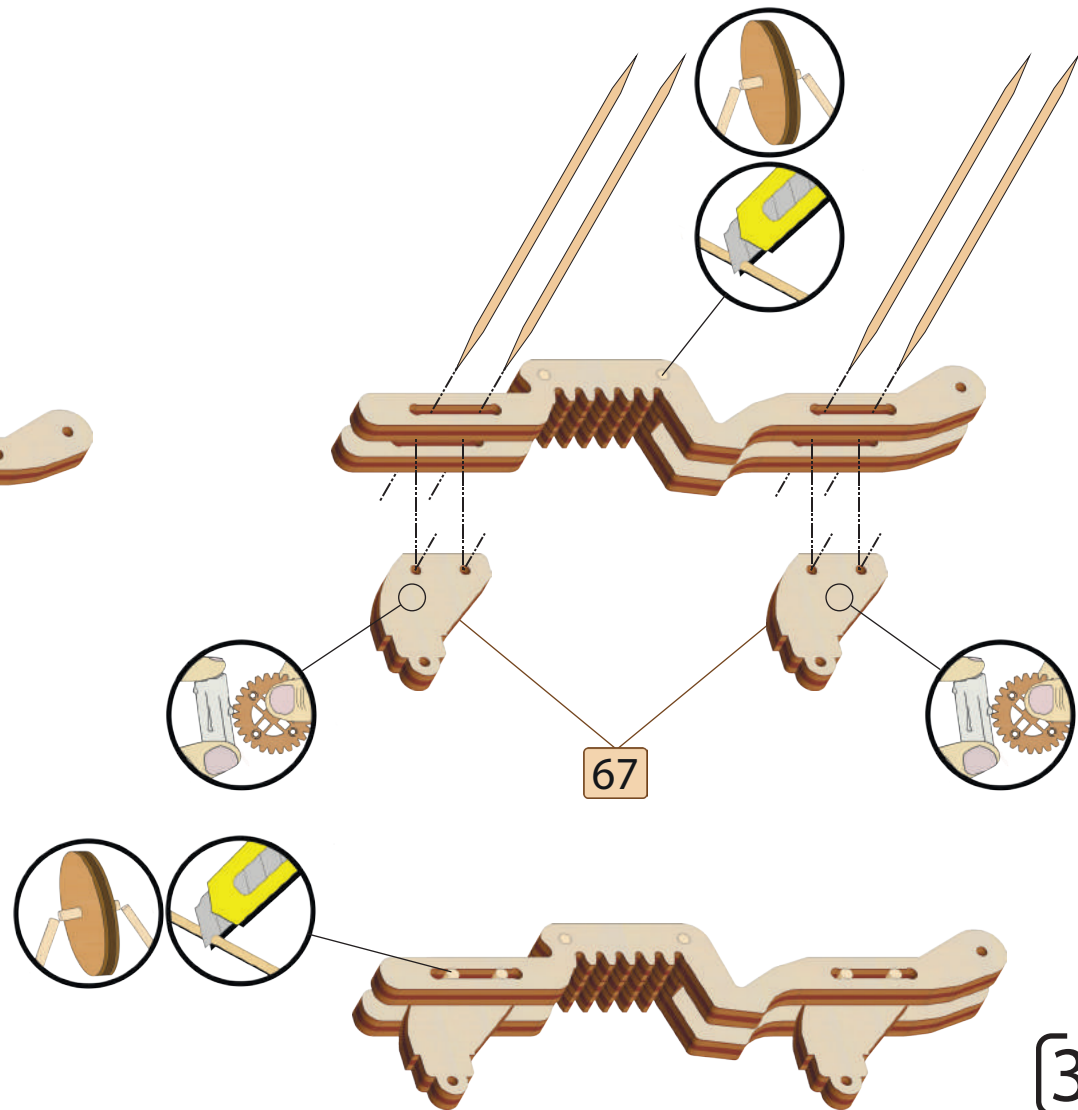

67

[39]



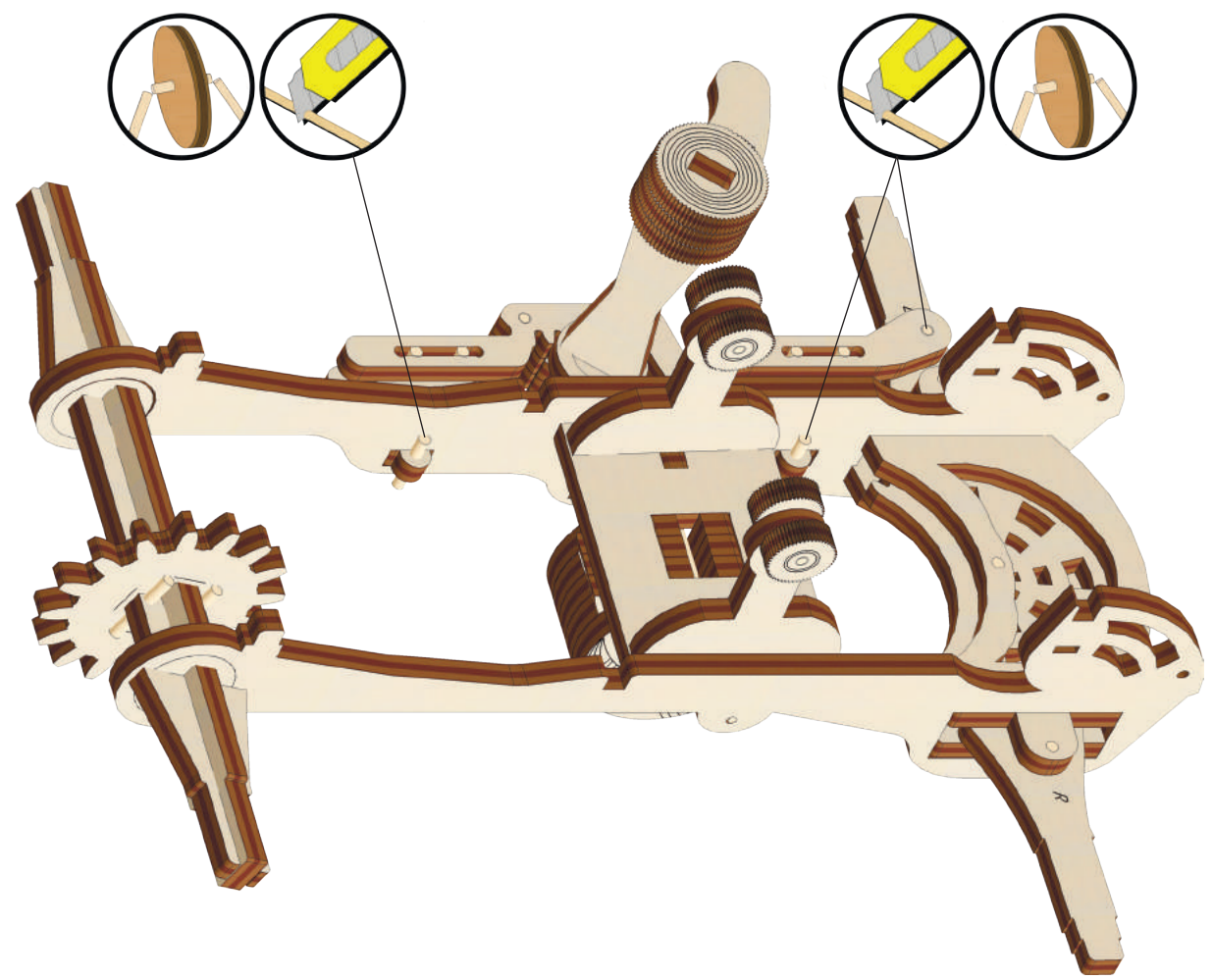
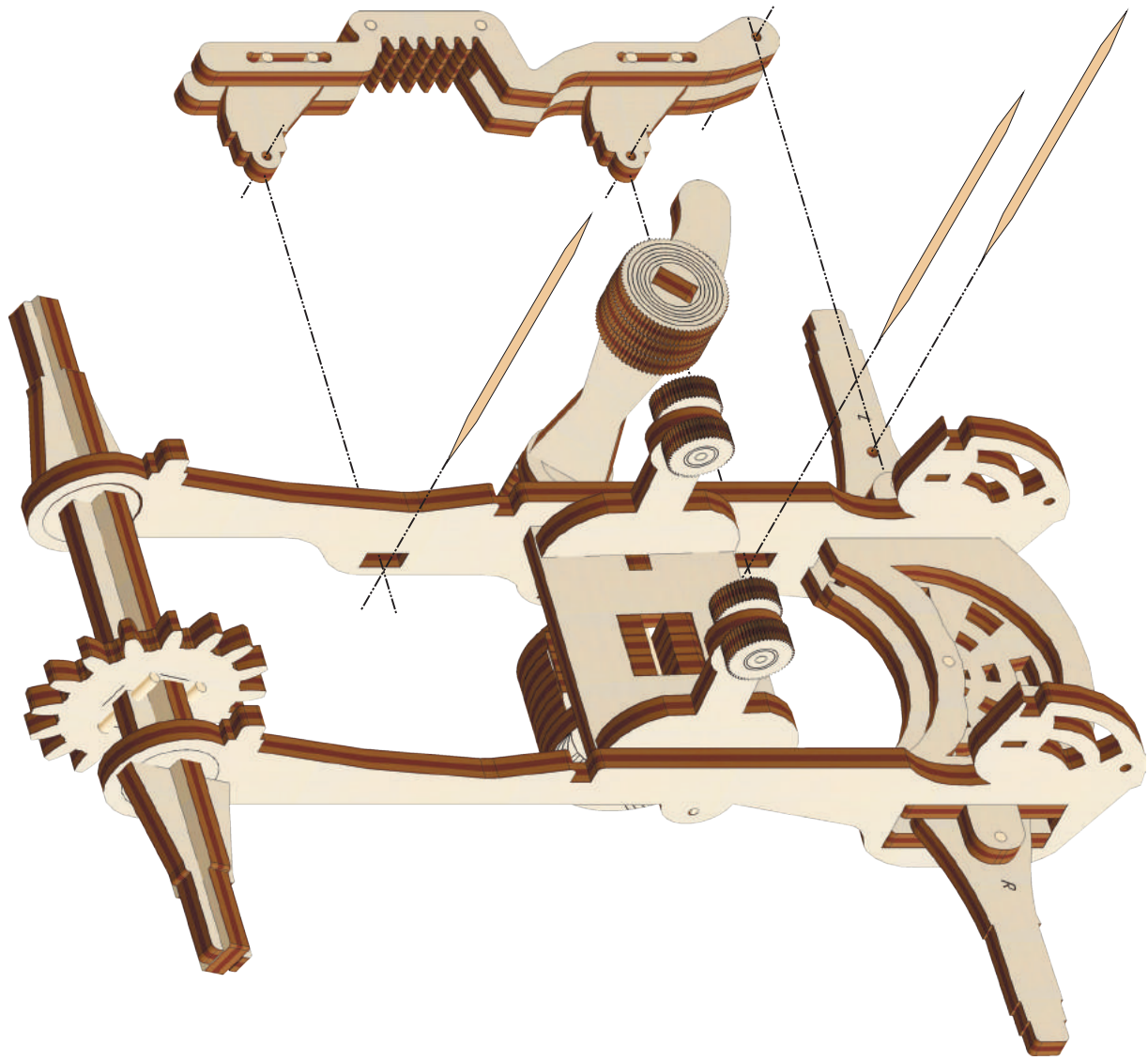

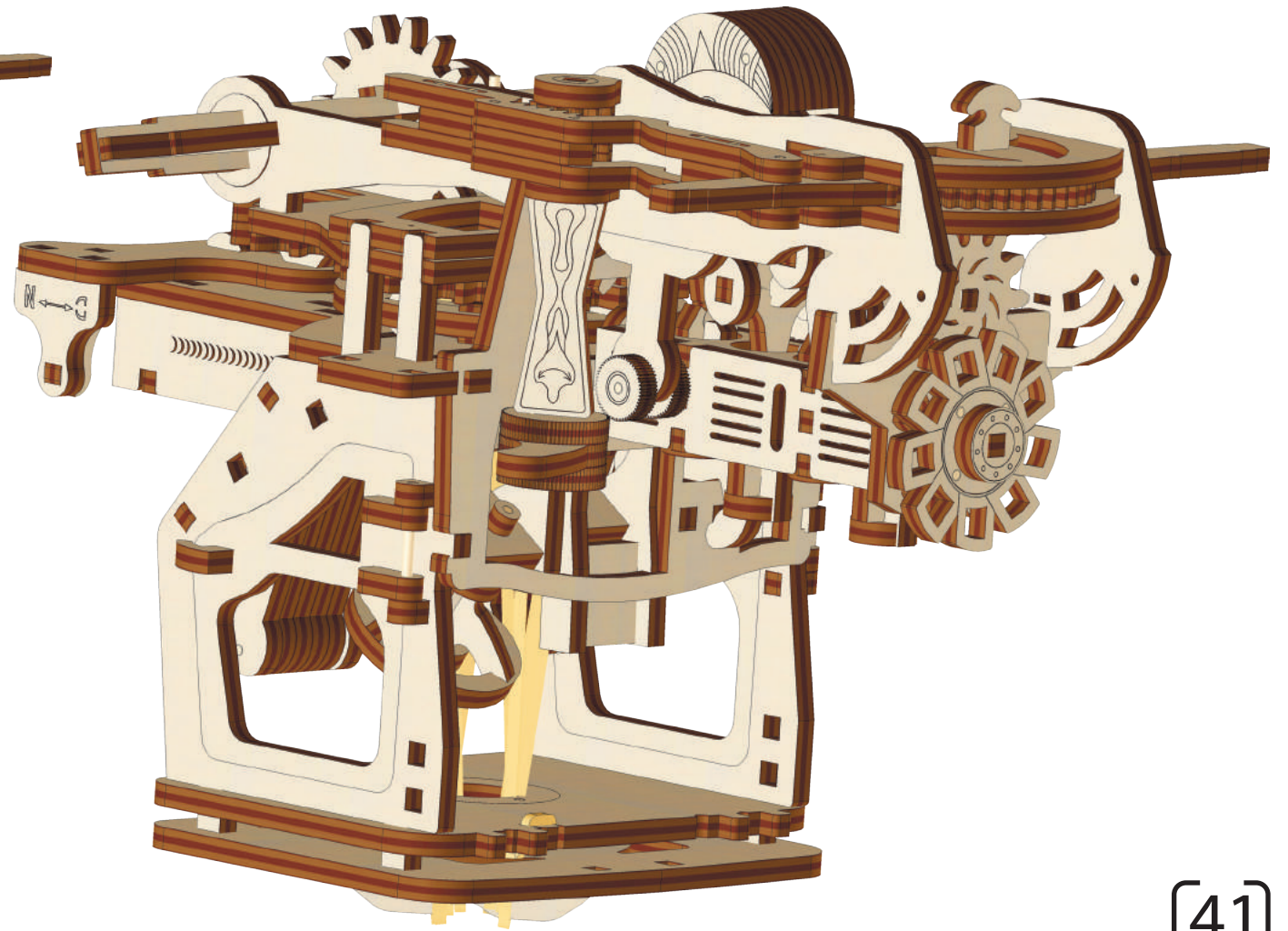
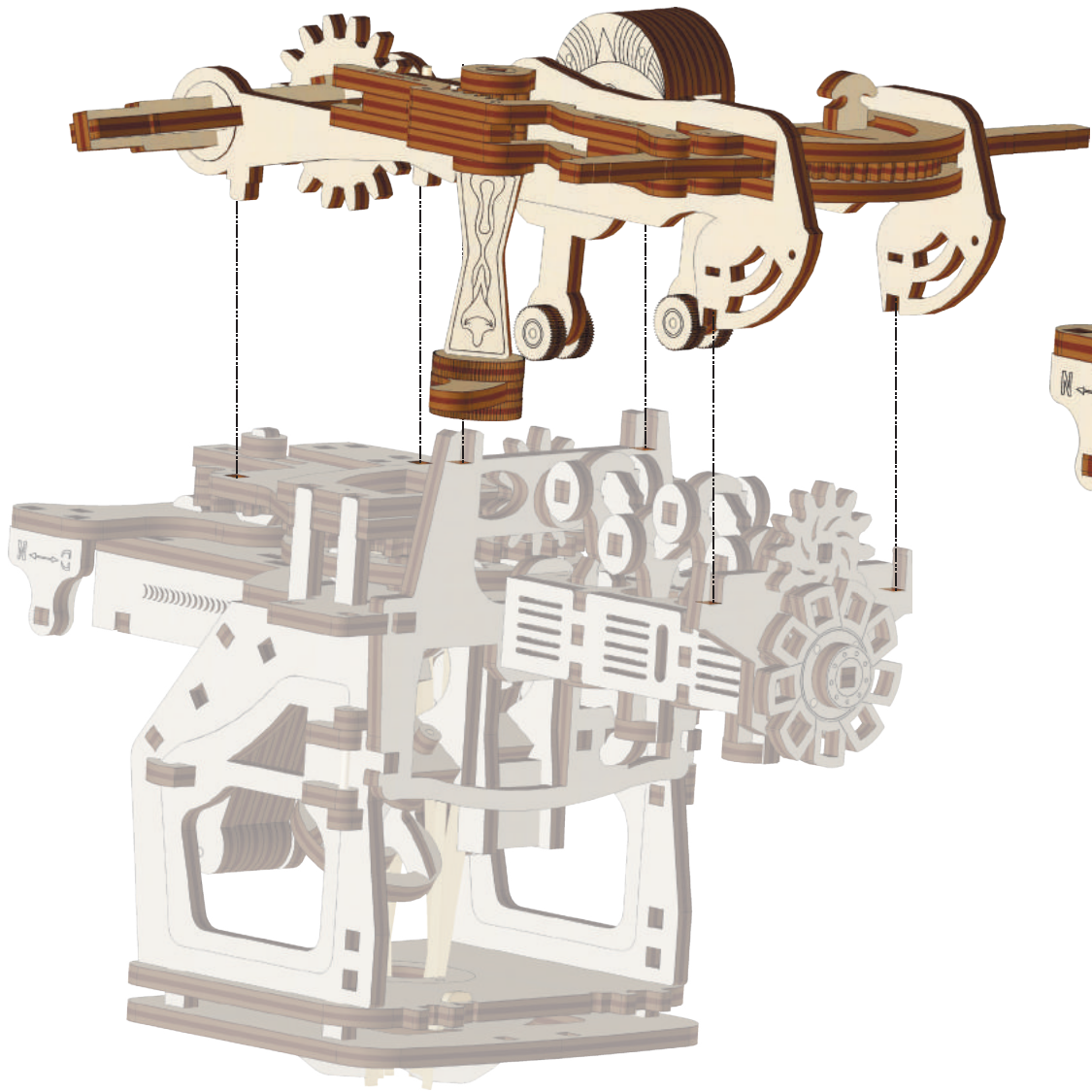

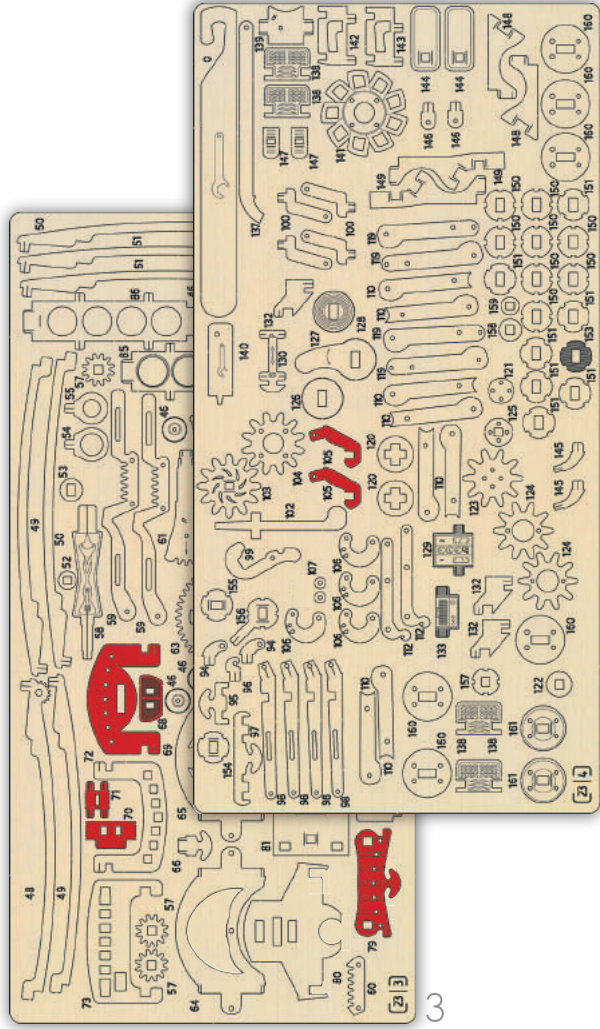

4

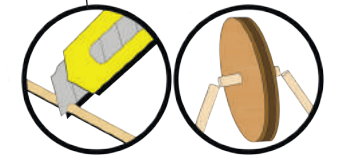
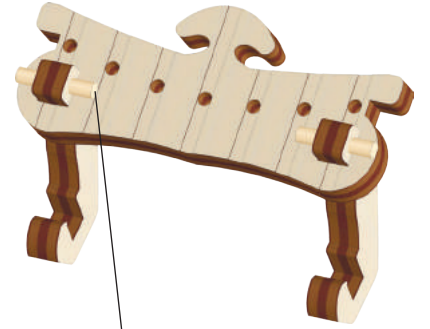
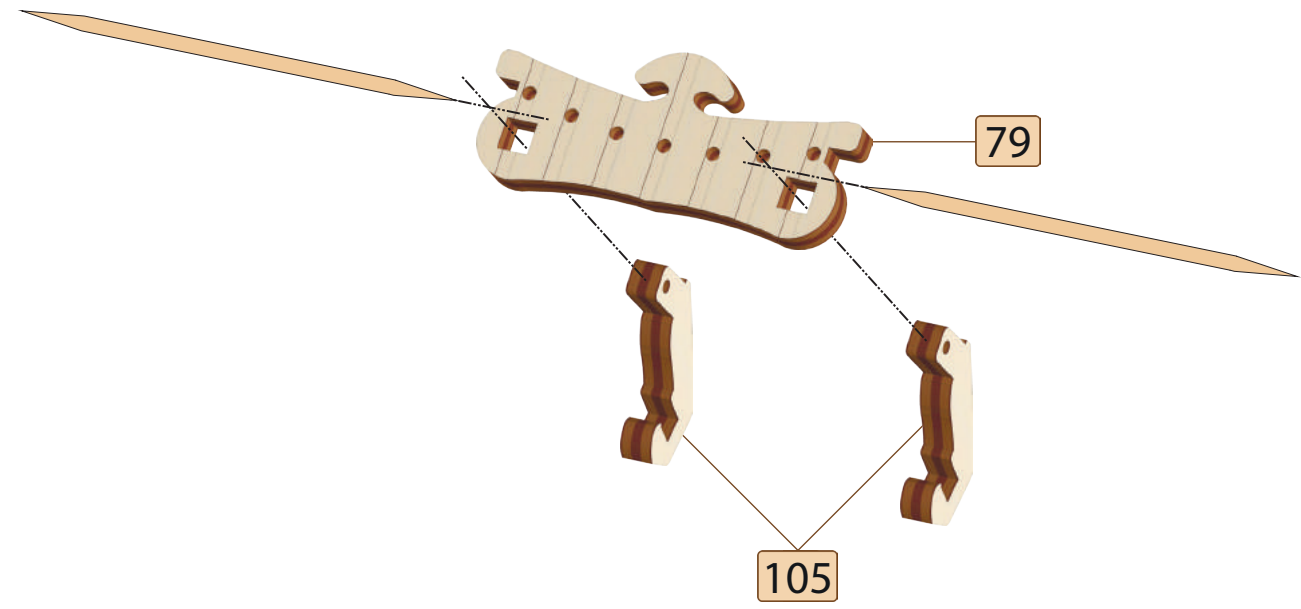
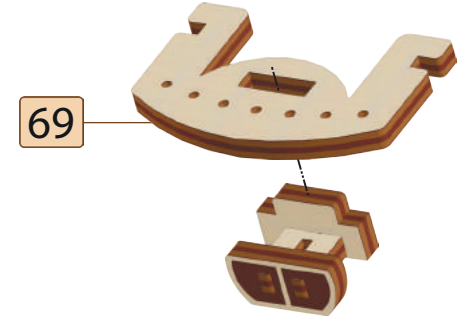
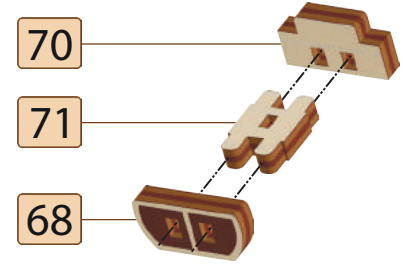

[42]

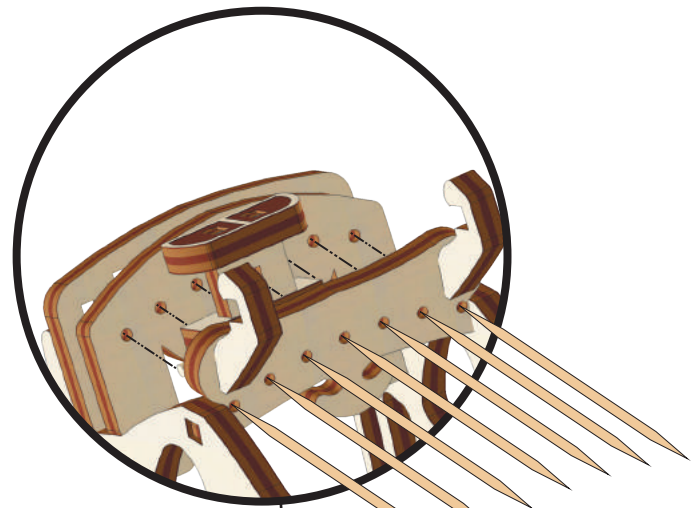
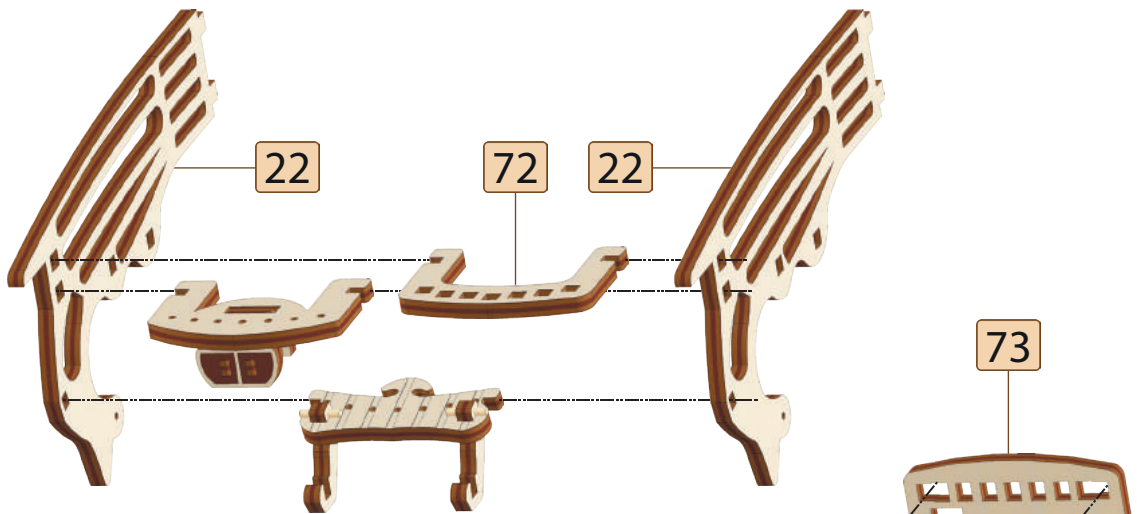
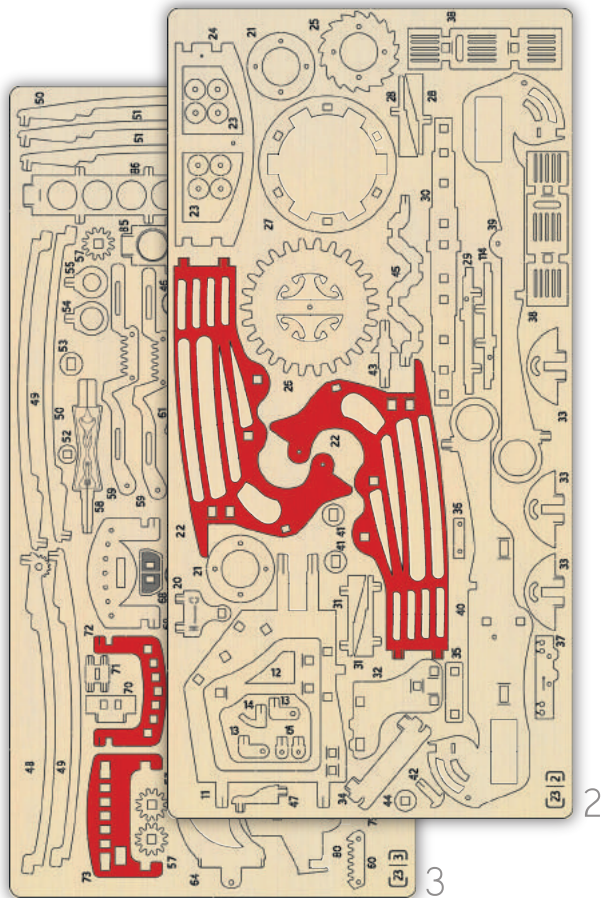

[43]

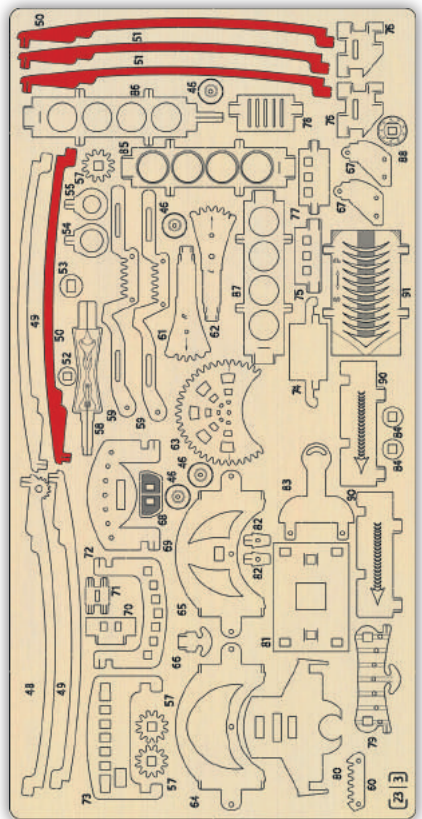

3

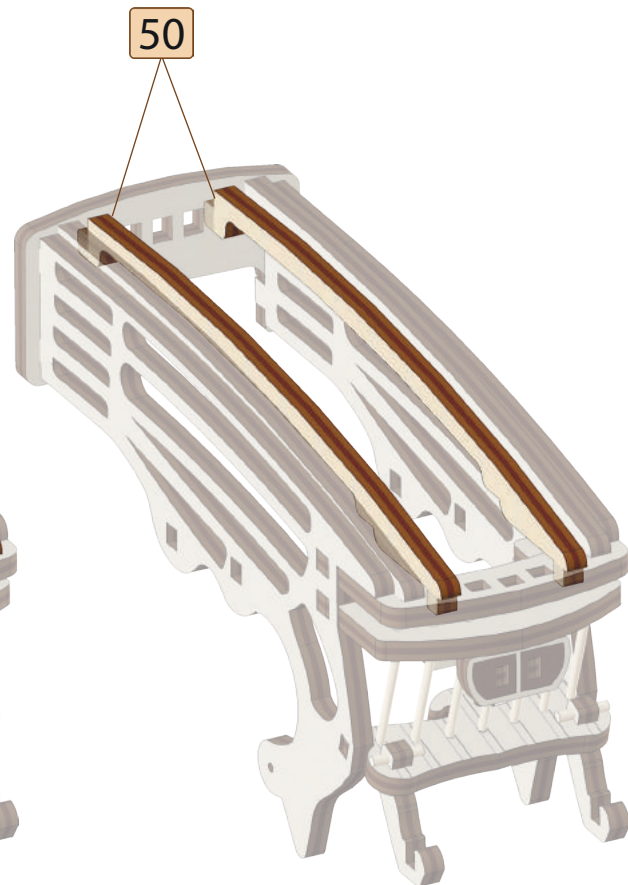
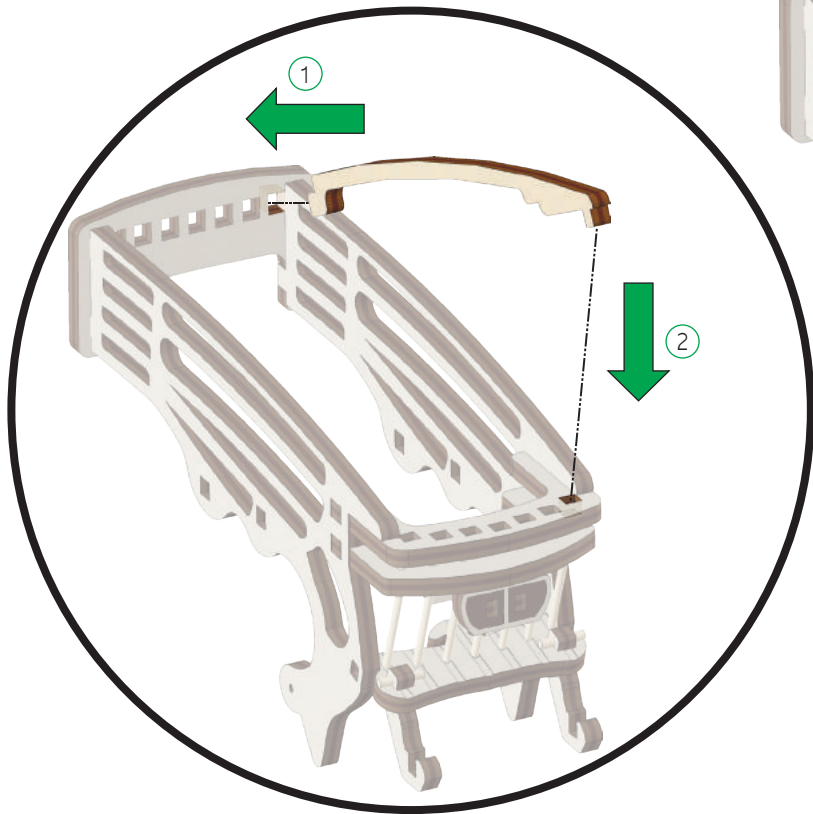

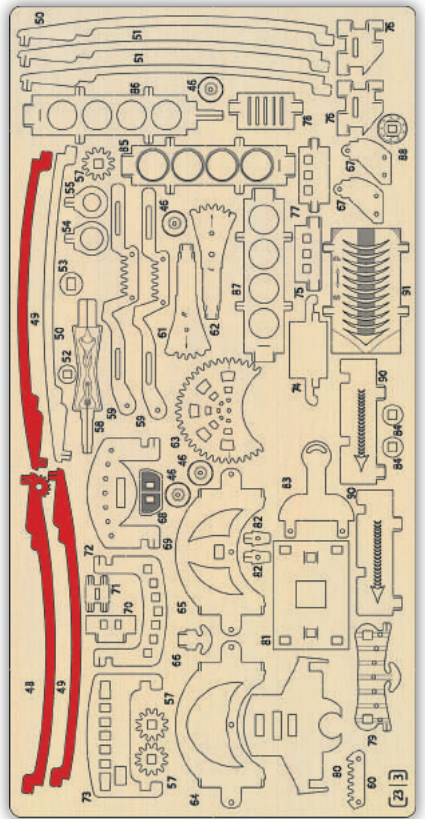

3

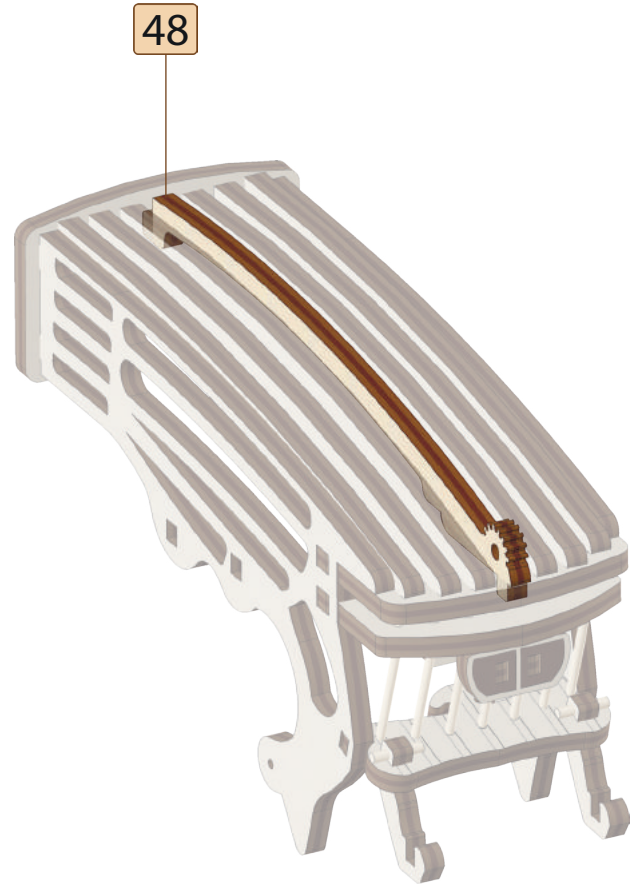

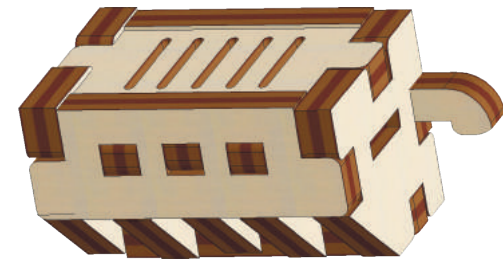
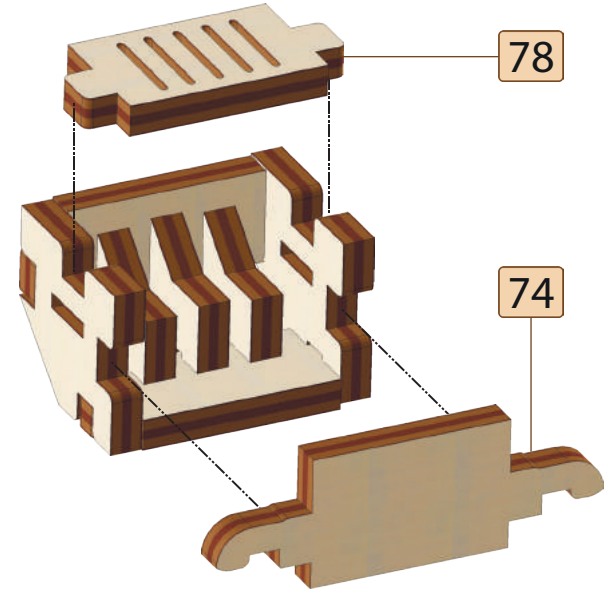
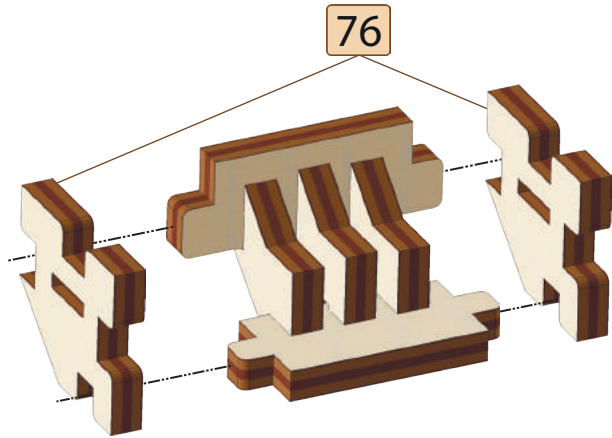
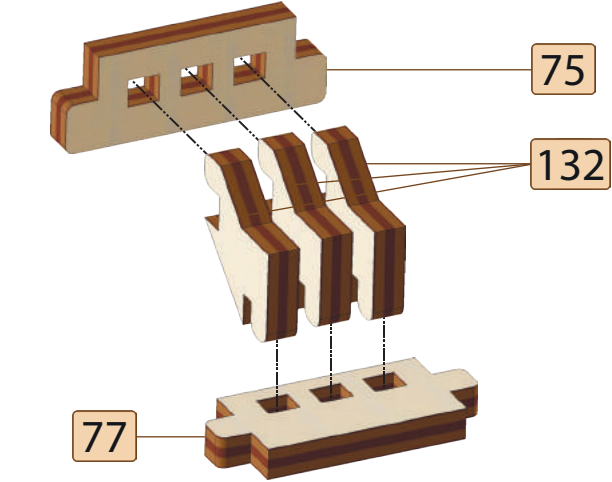
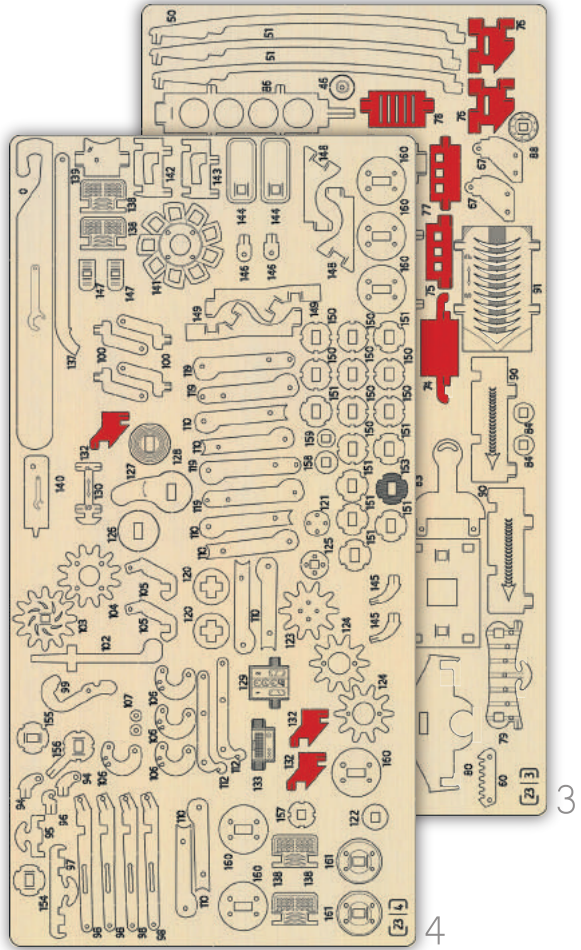





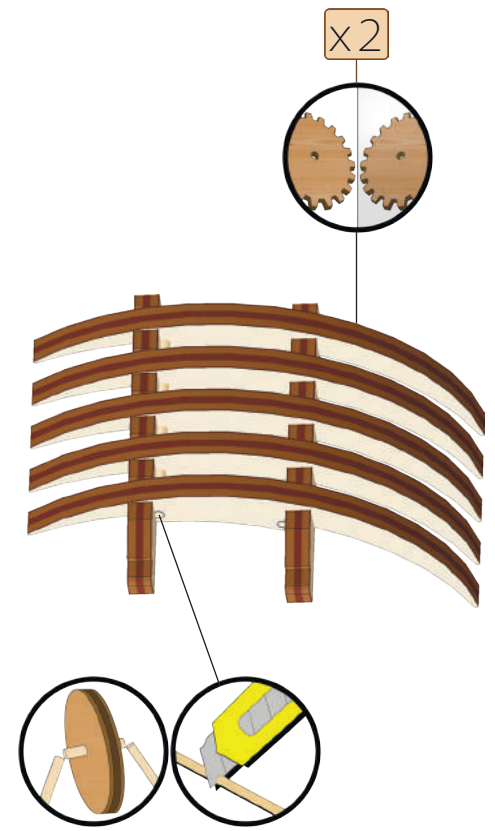
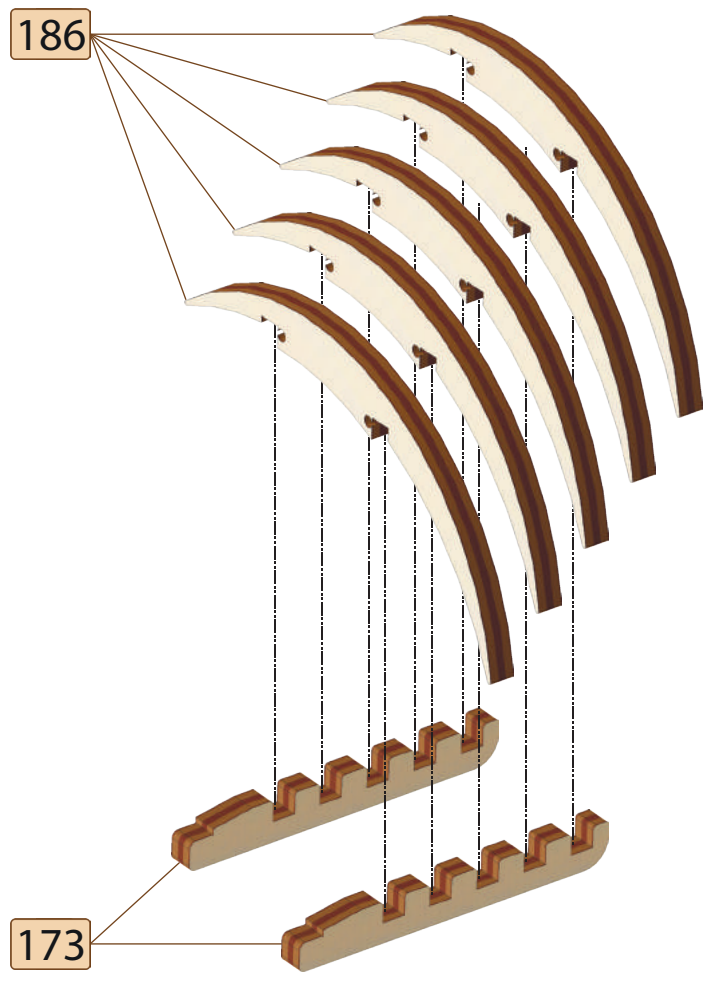



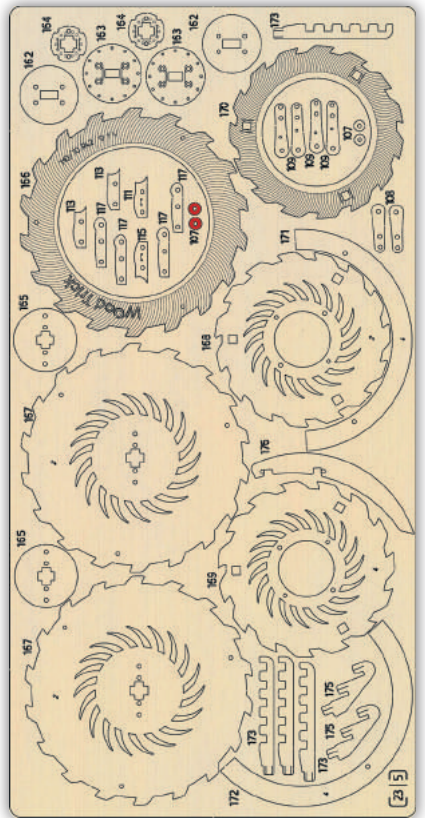

5

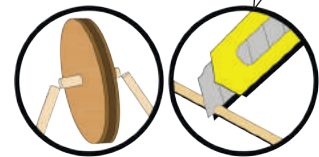
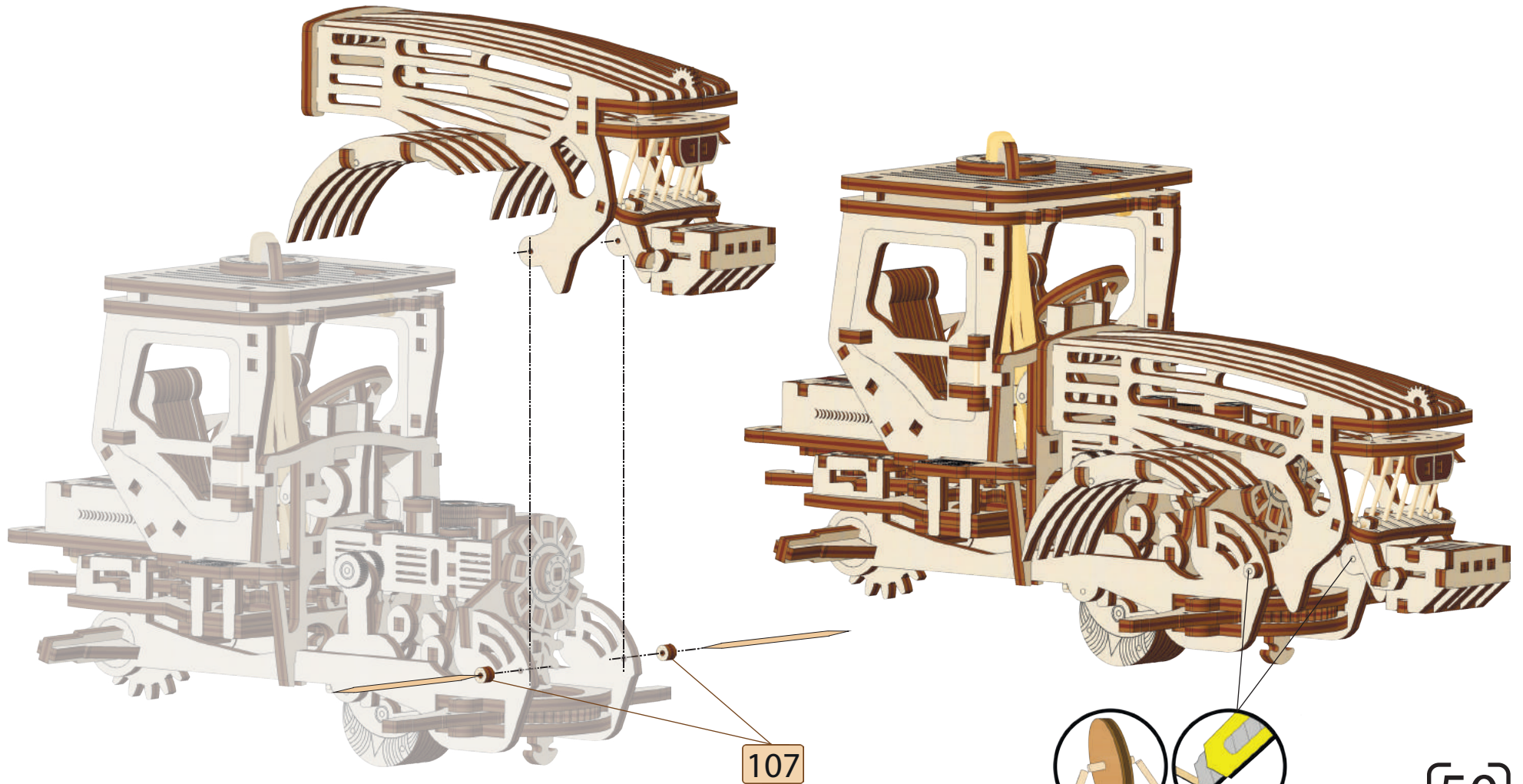

[50]

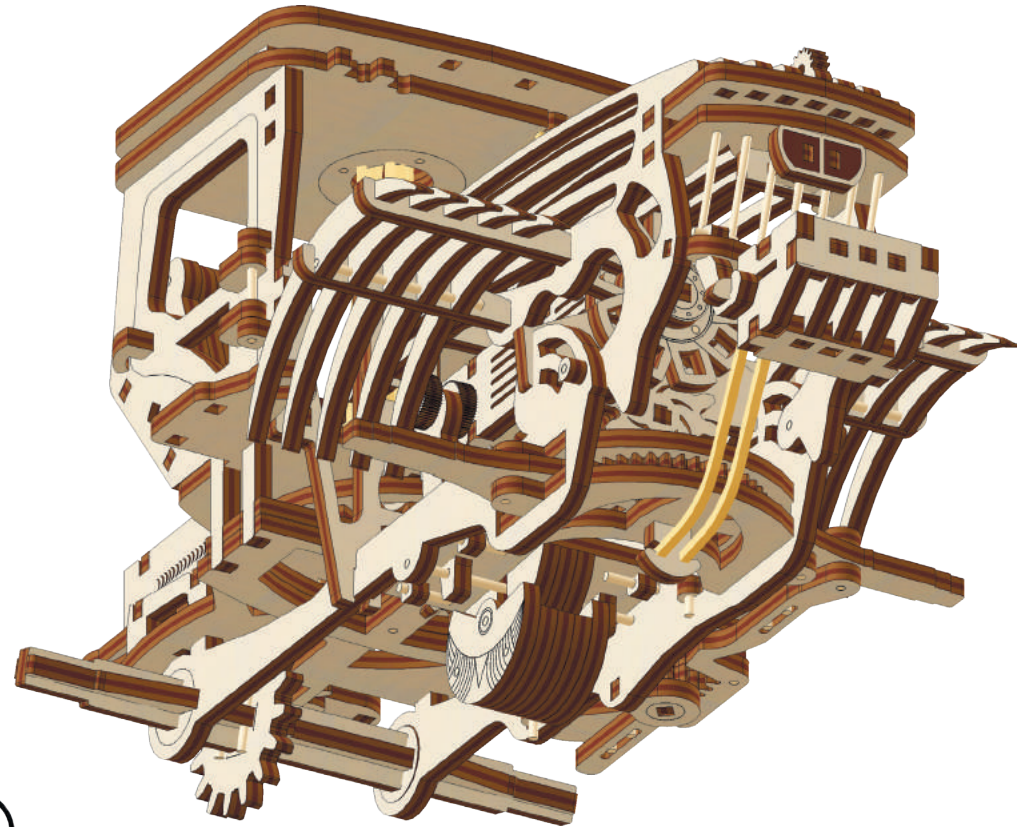
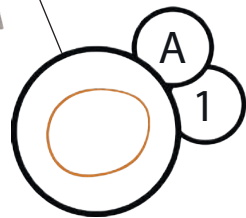
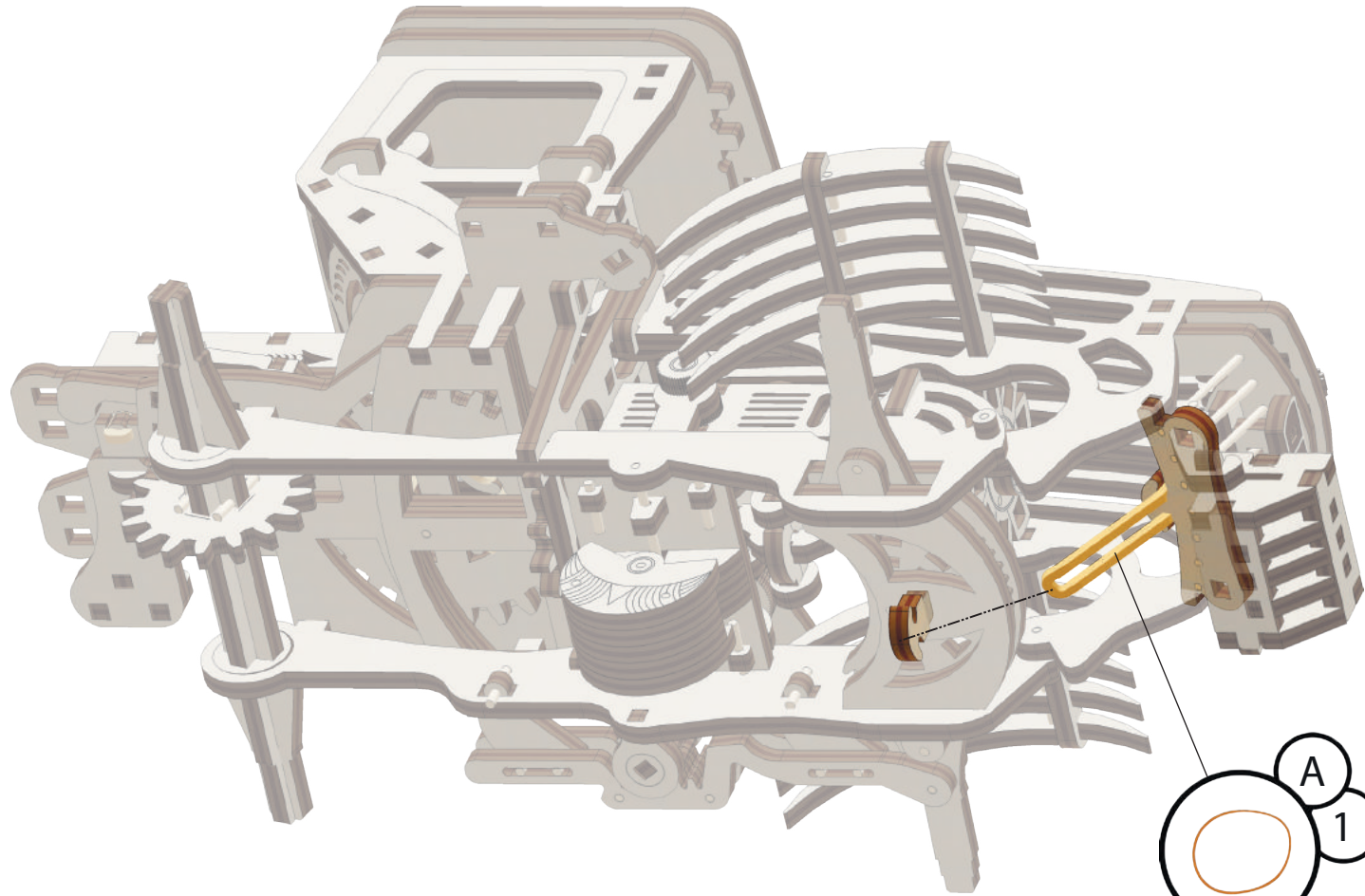

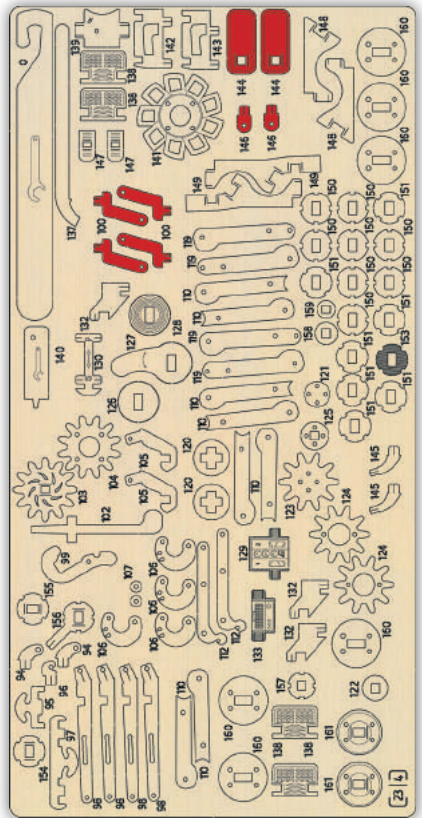

4

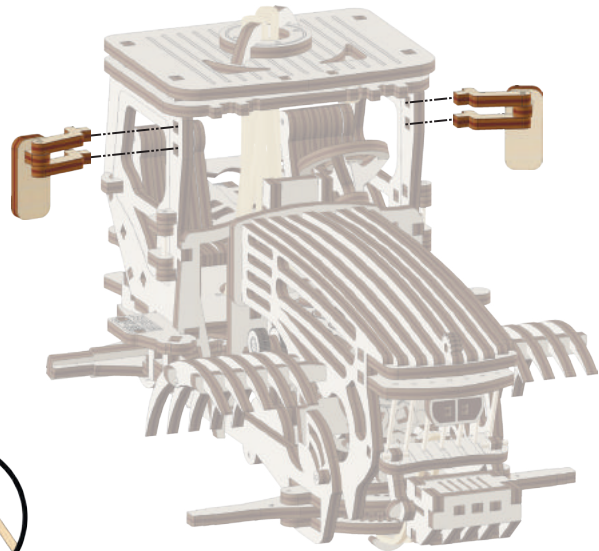
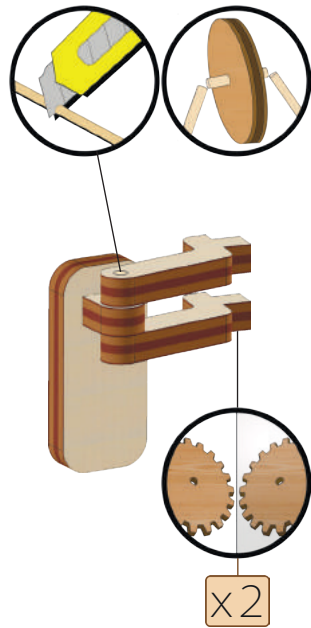
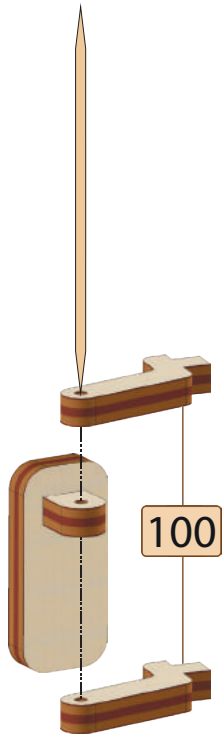
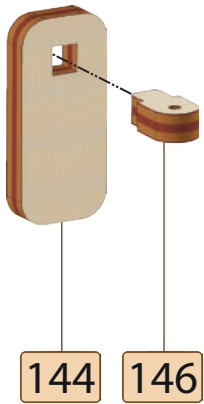

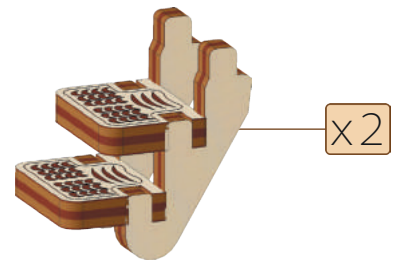
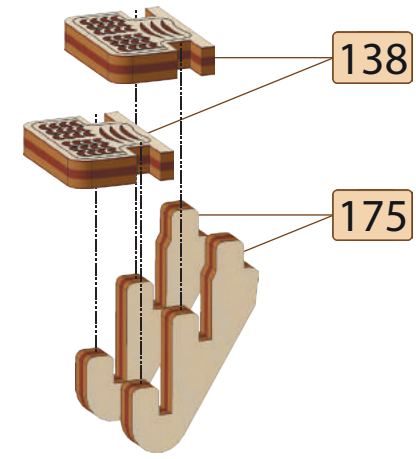
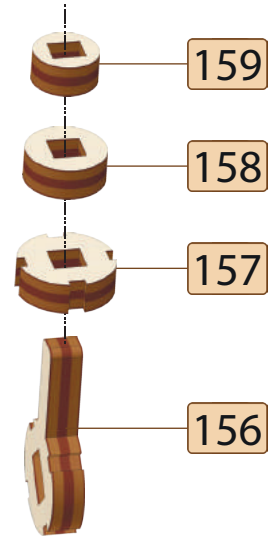
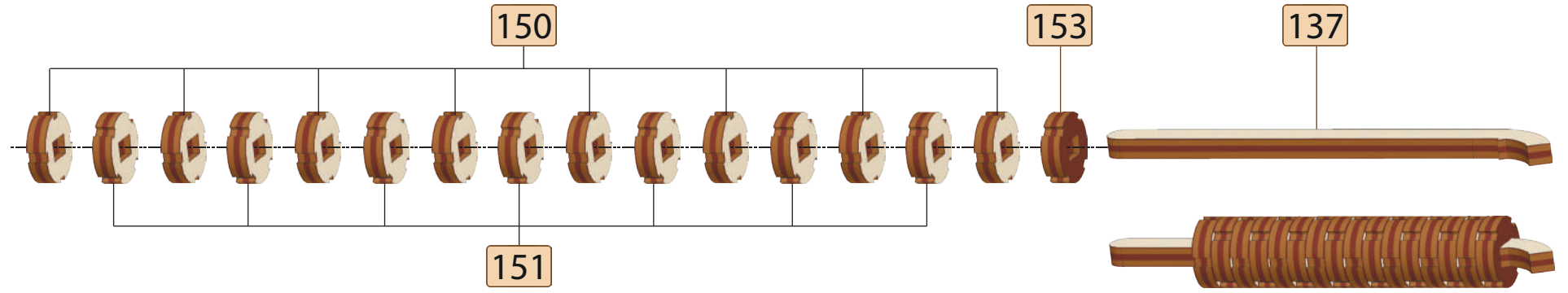
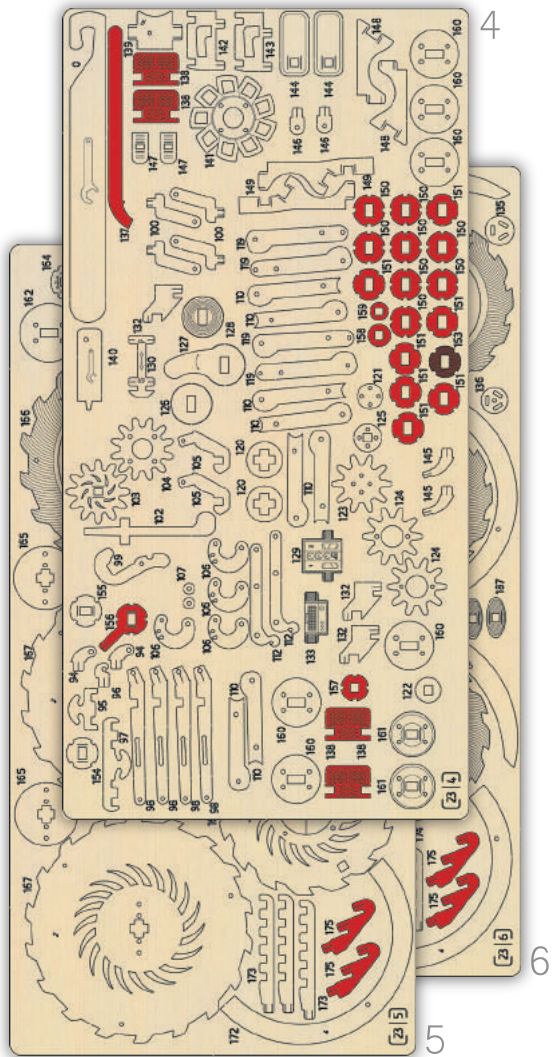

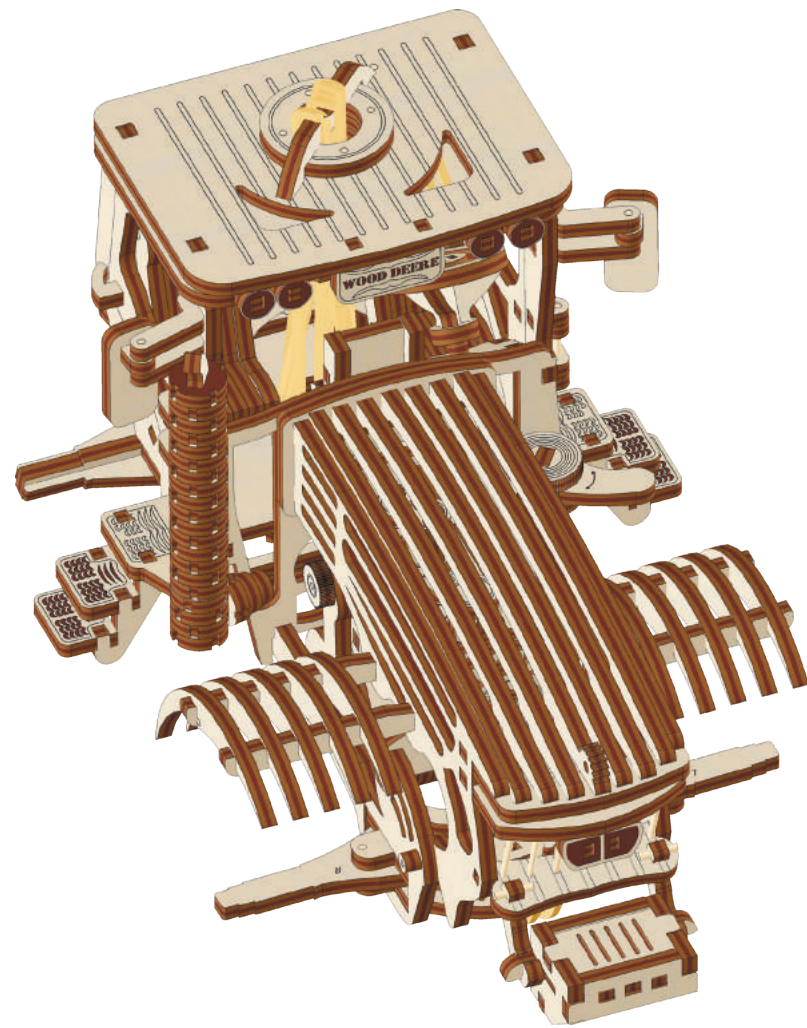
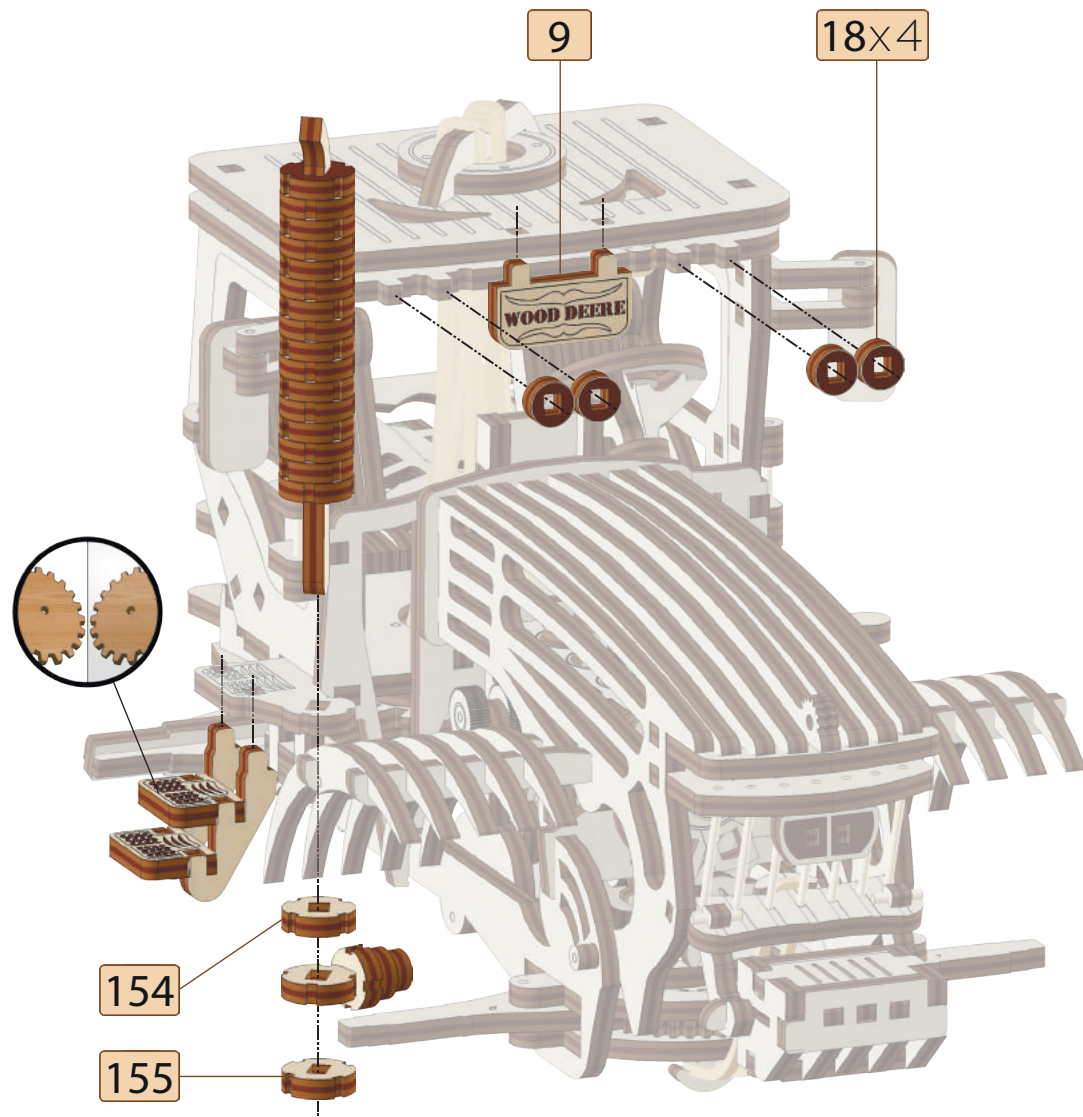
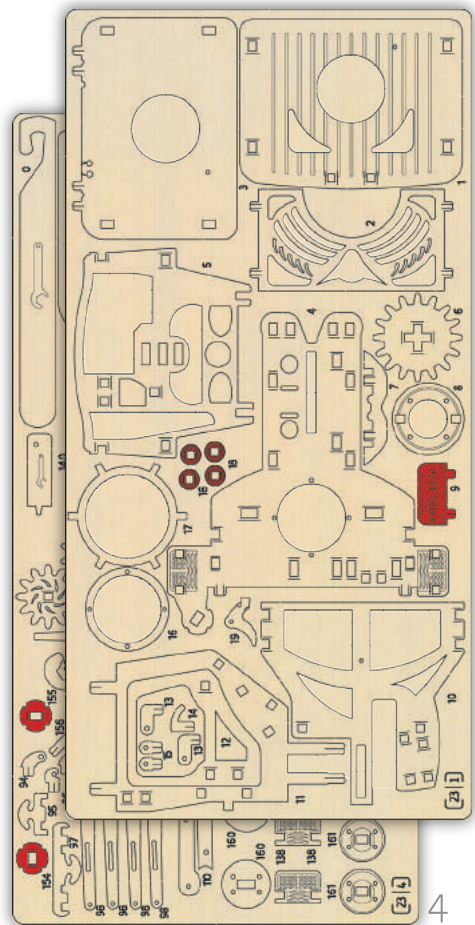

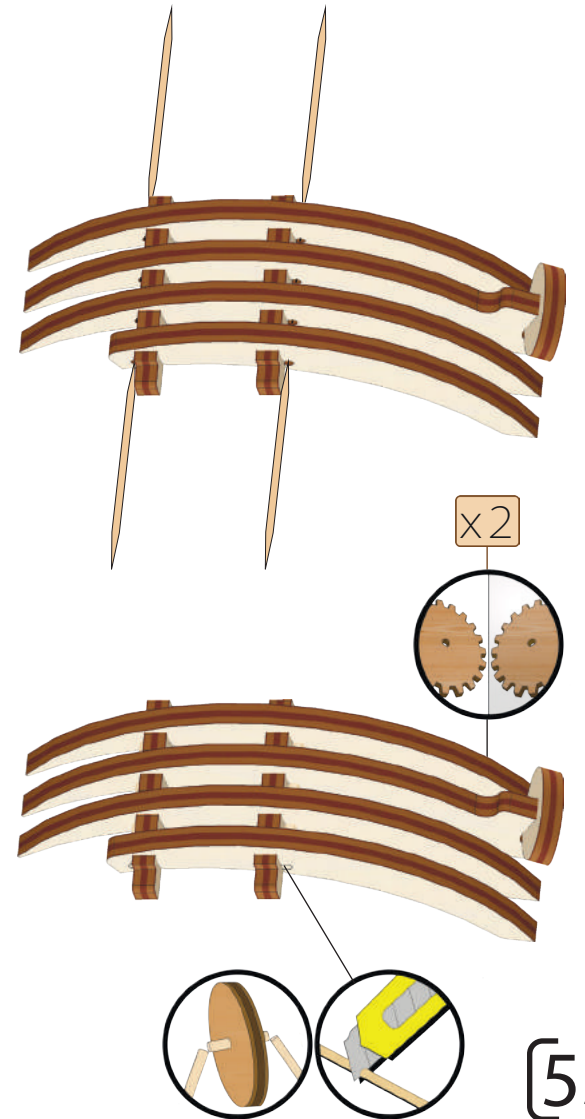
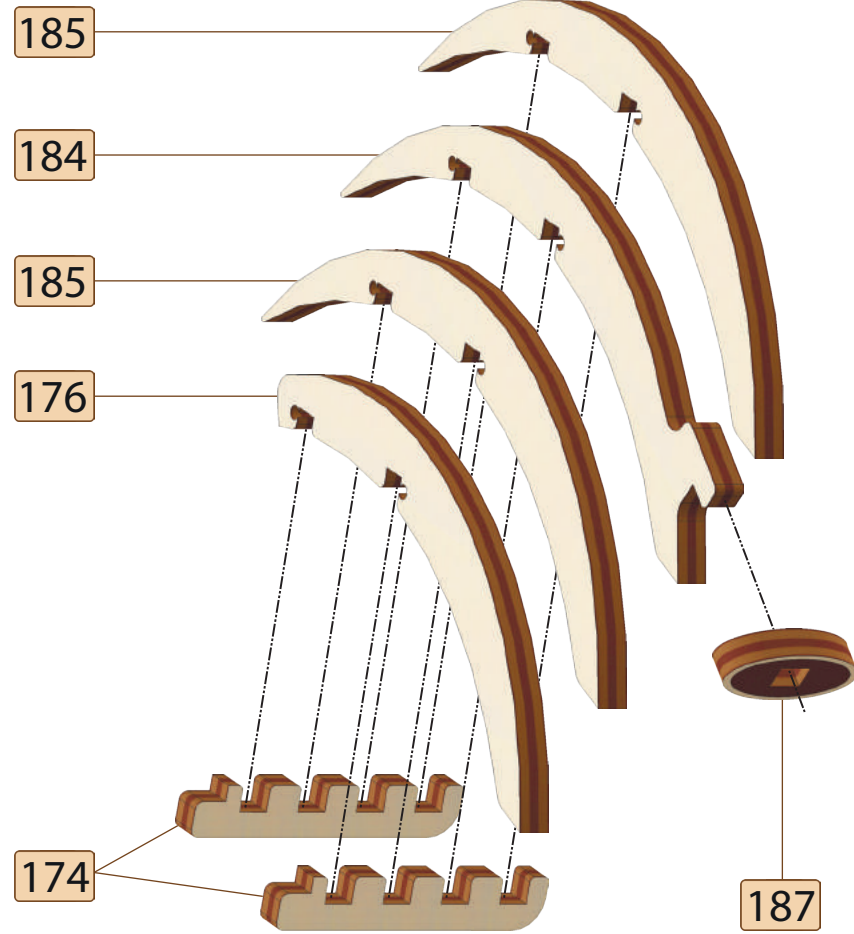
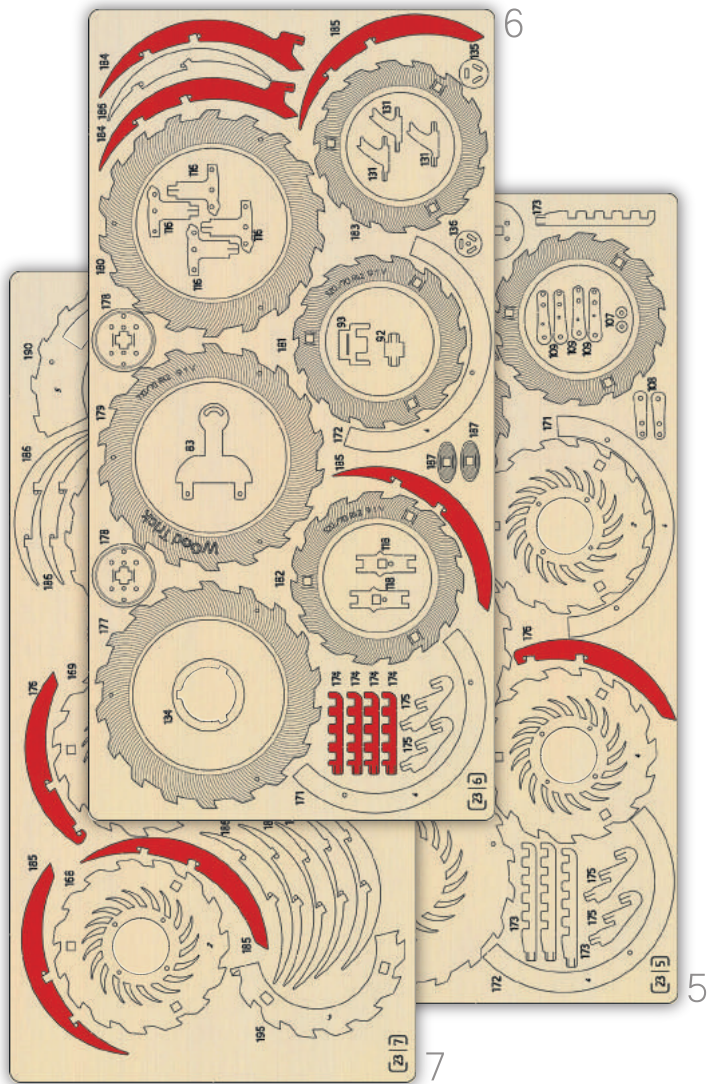



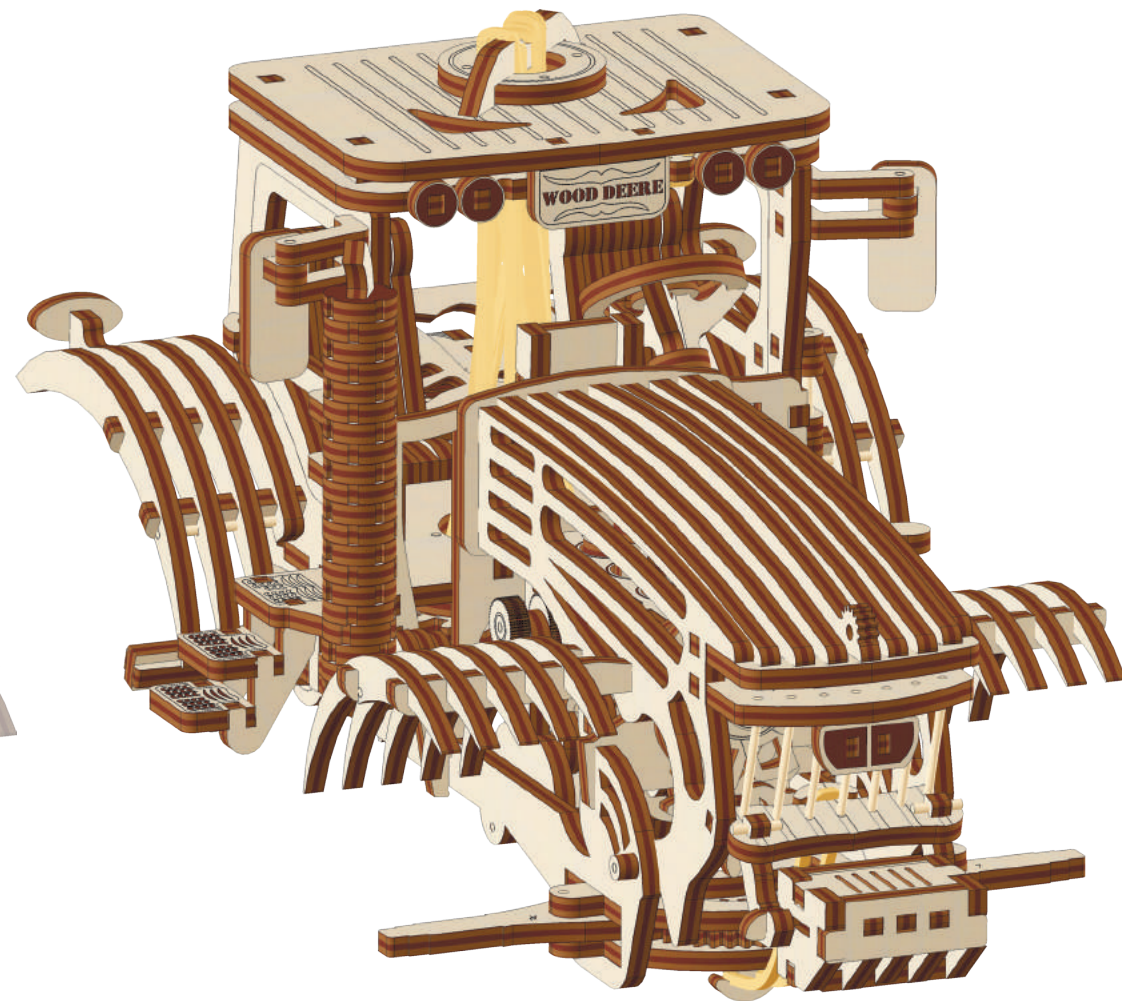
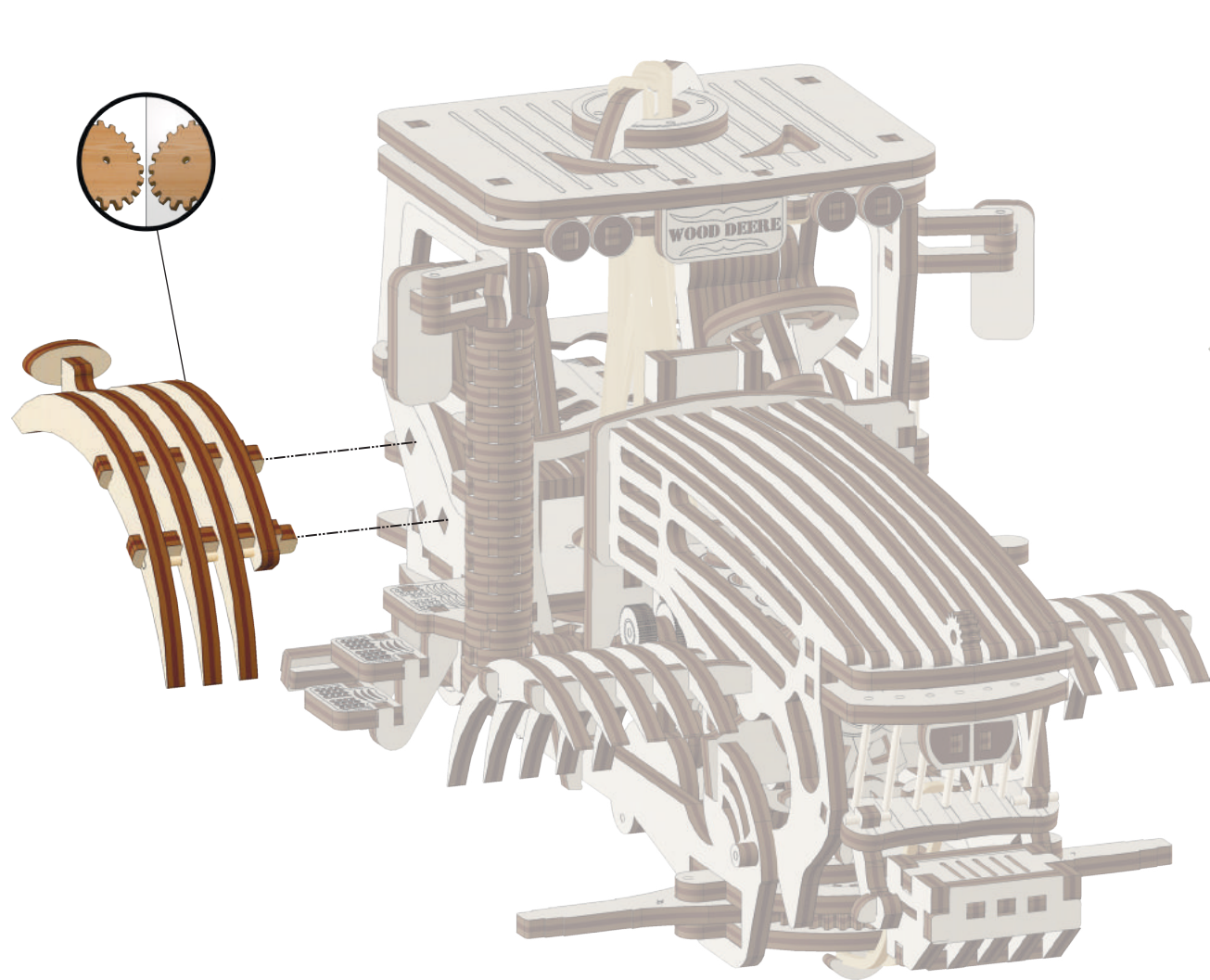

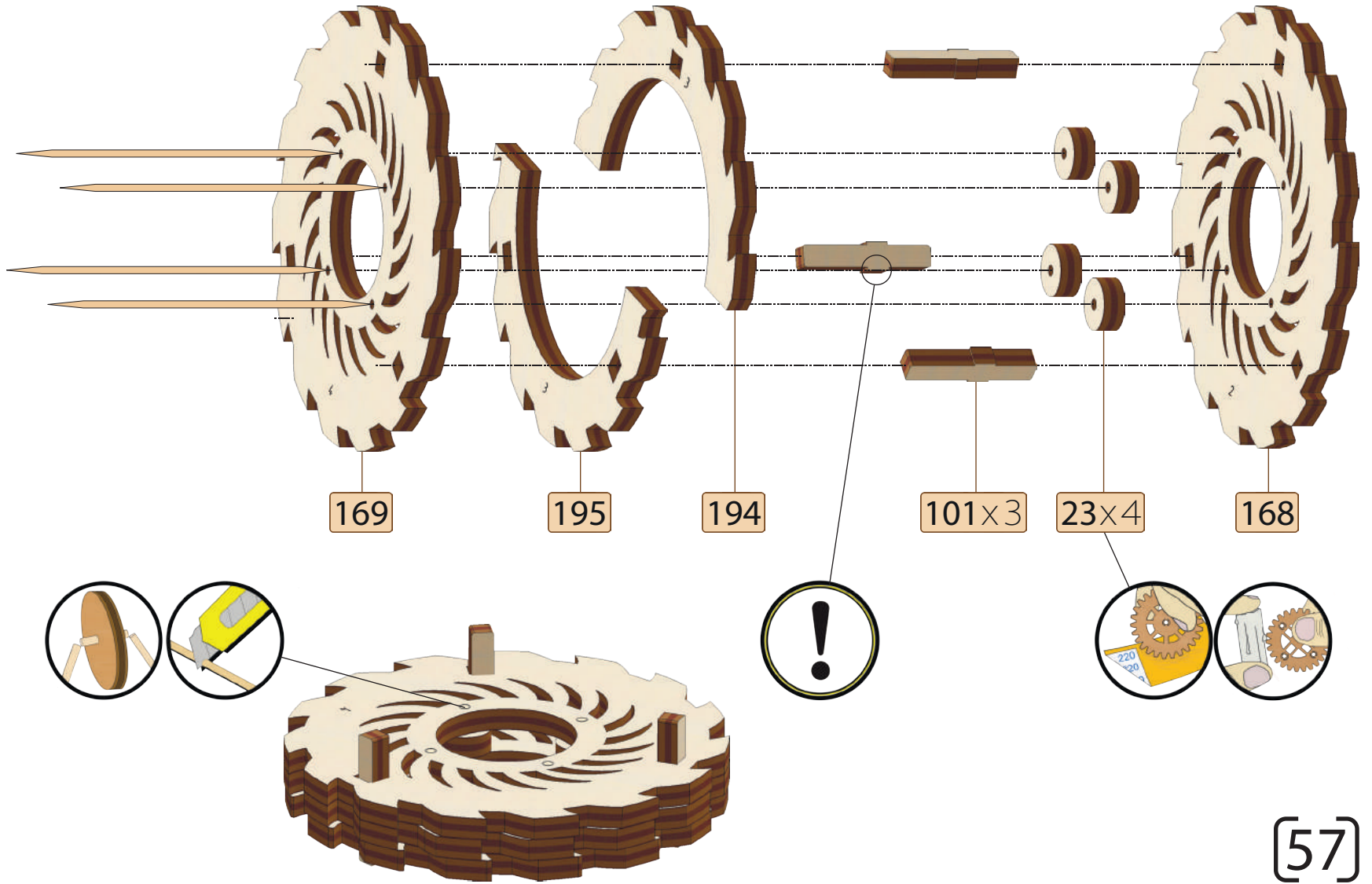

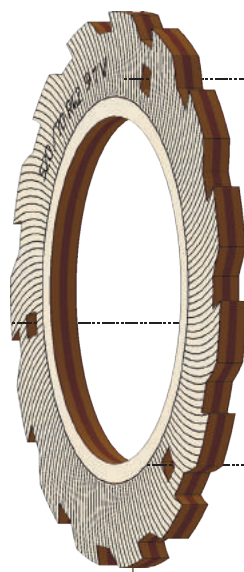

181

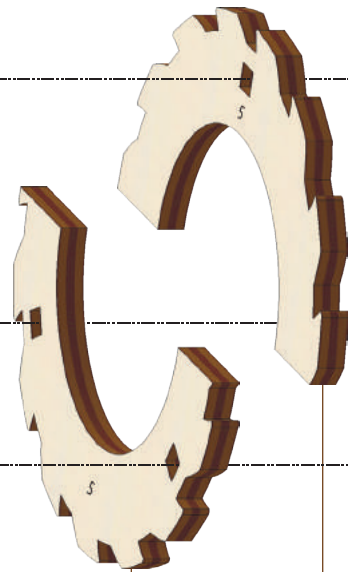

197



196

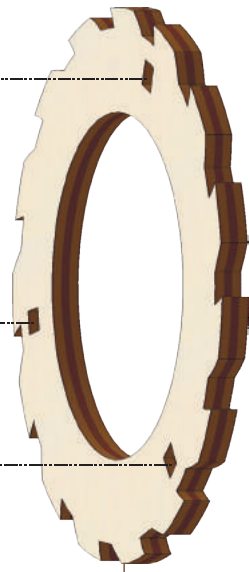

170

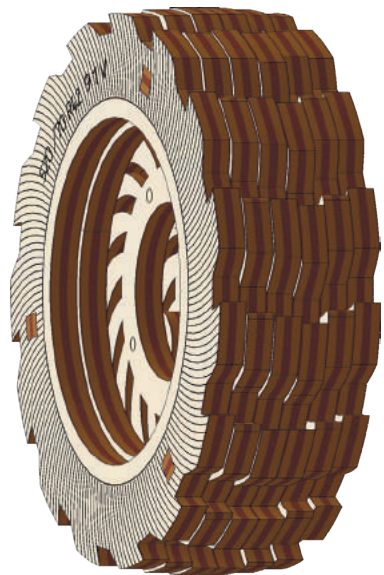

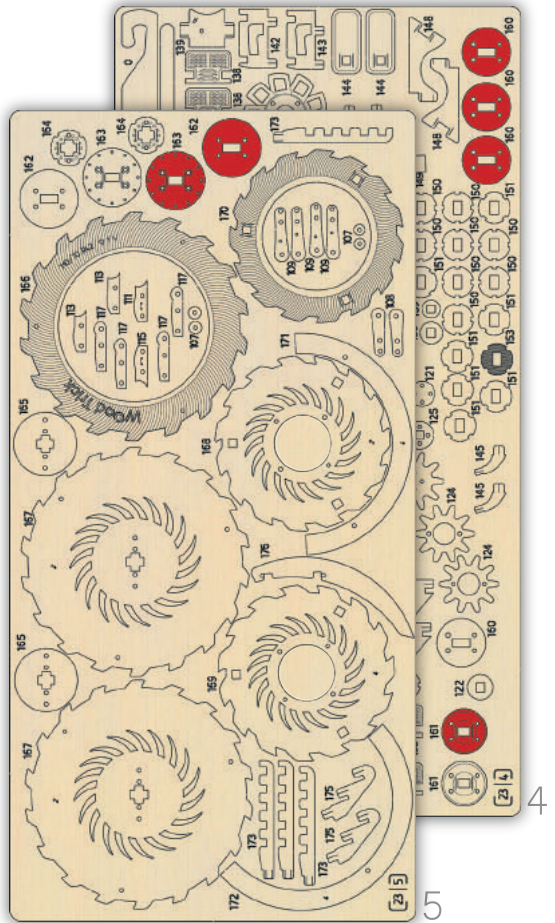

4

5

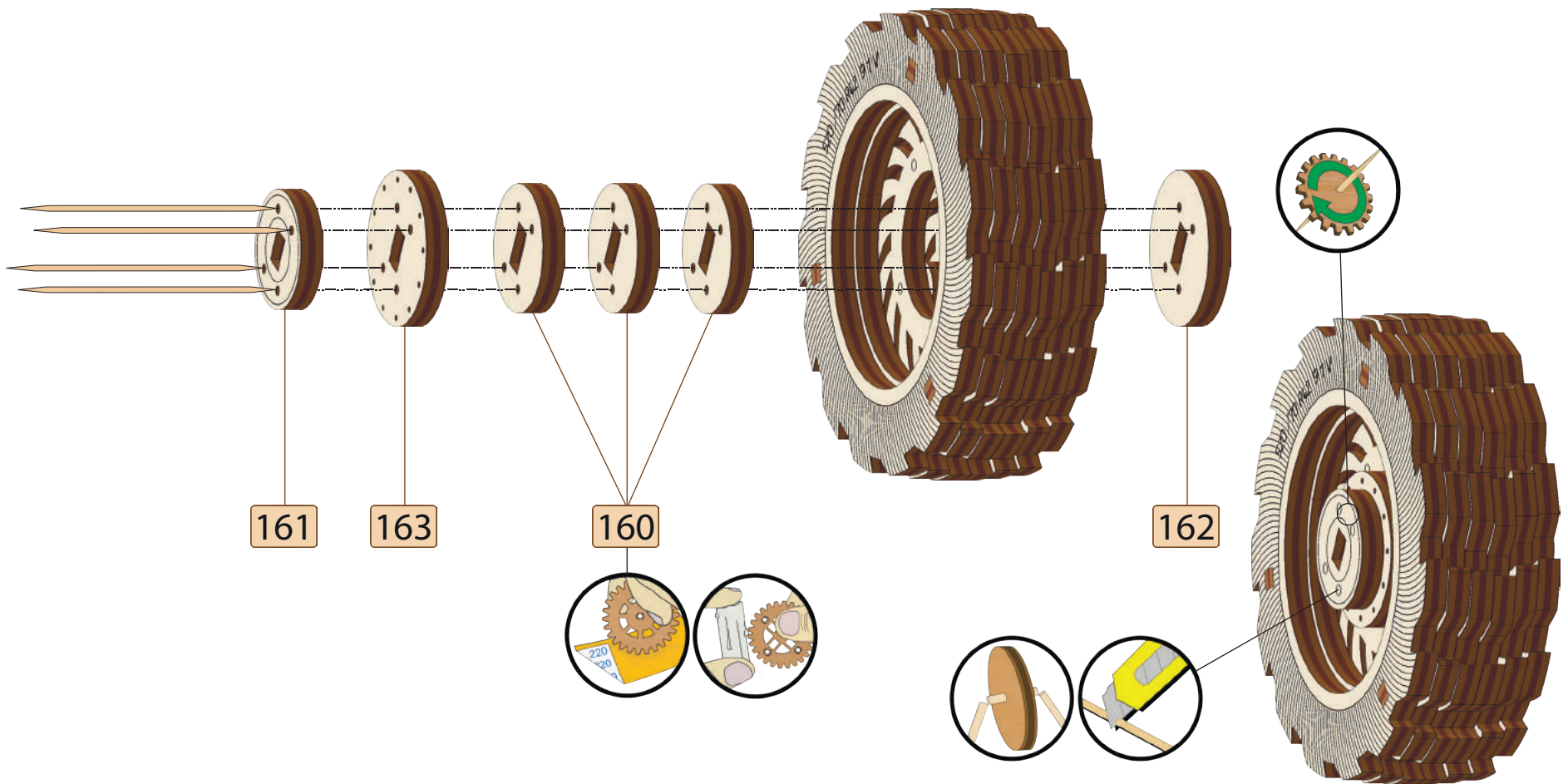

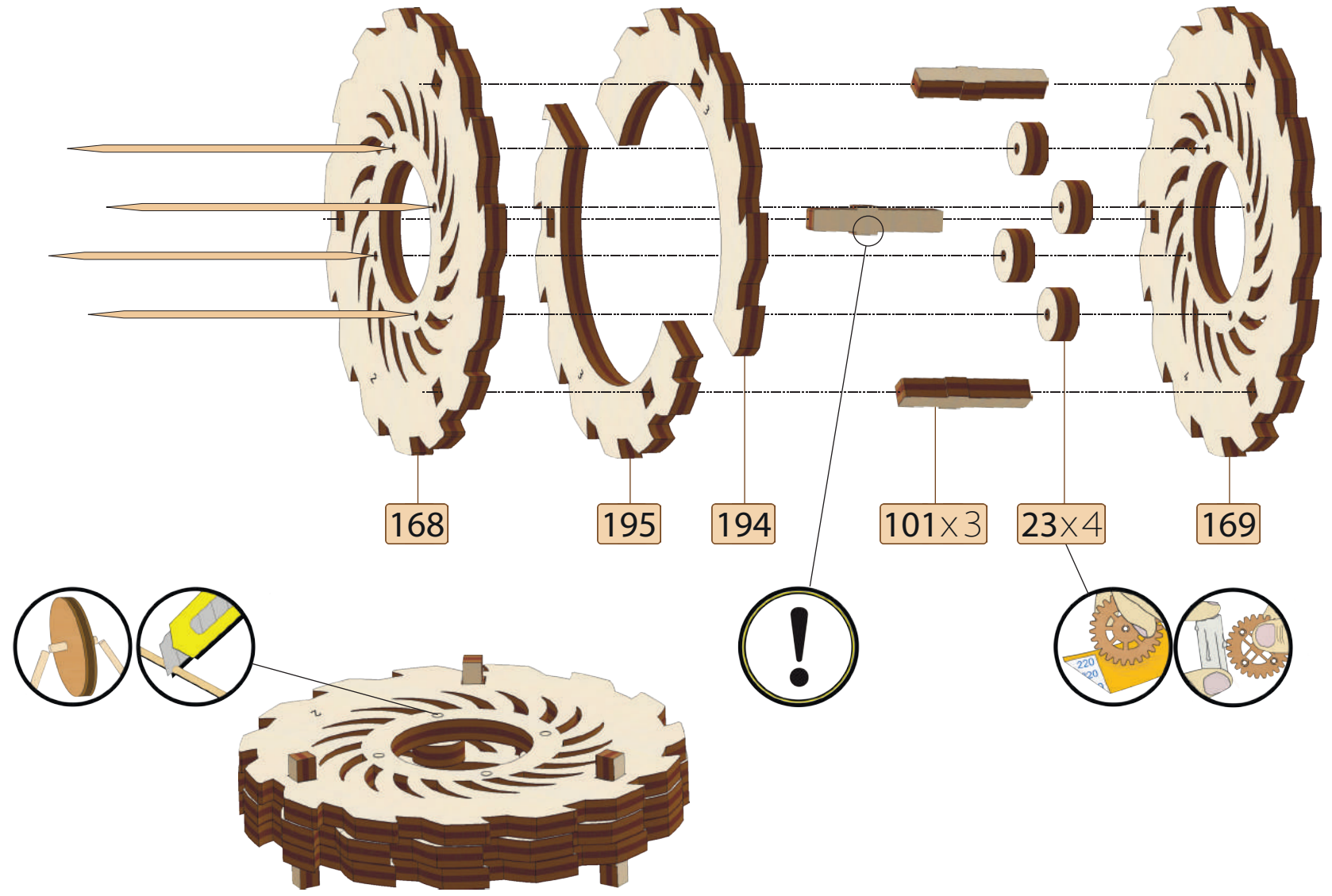
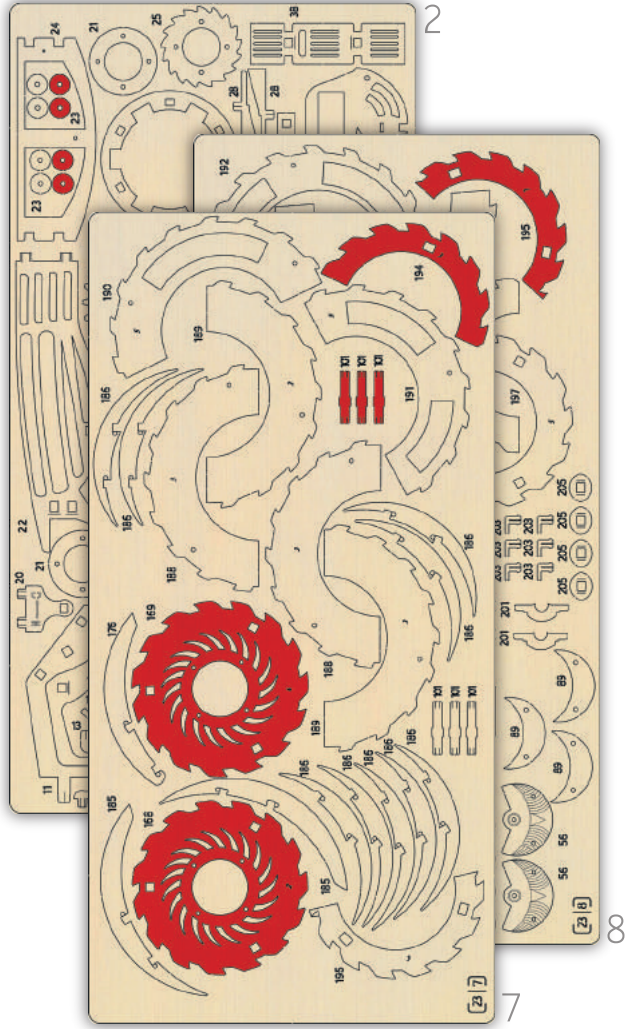

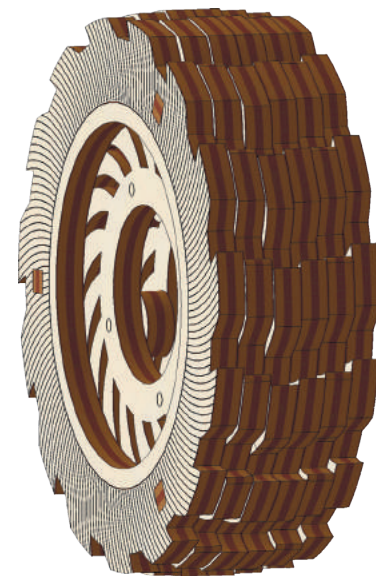
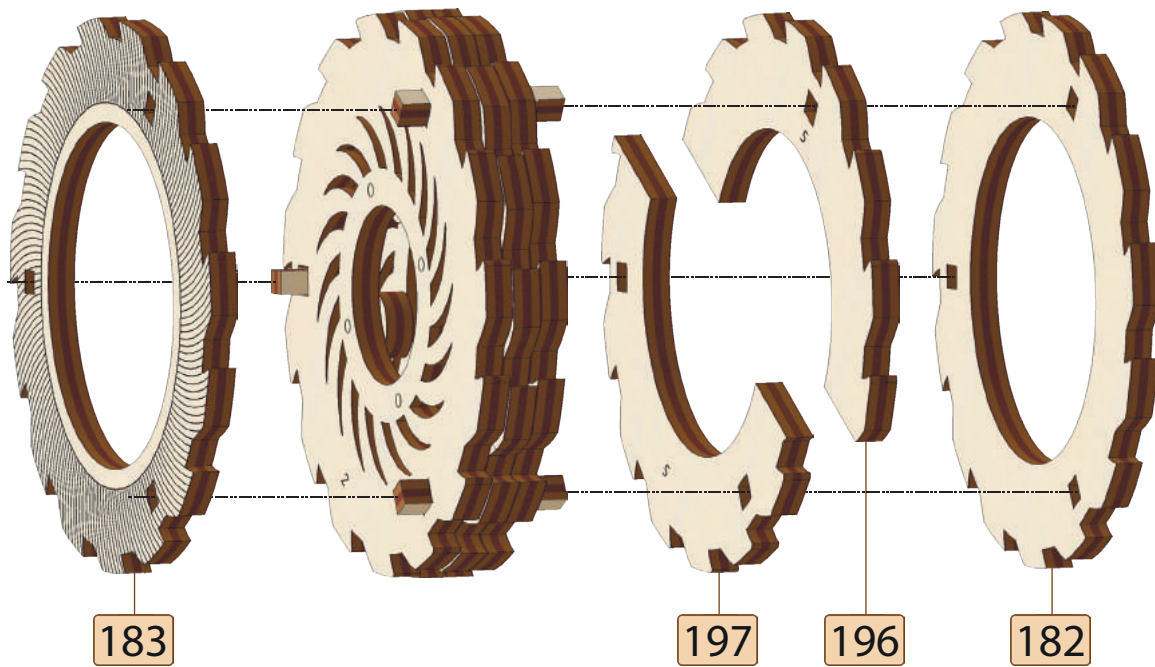
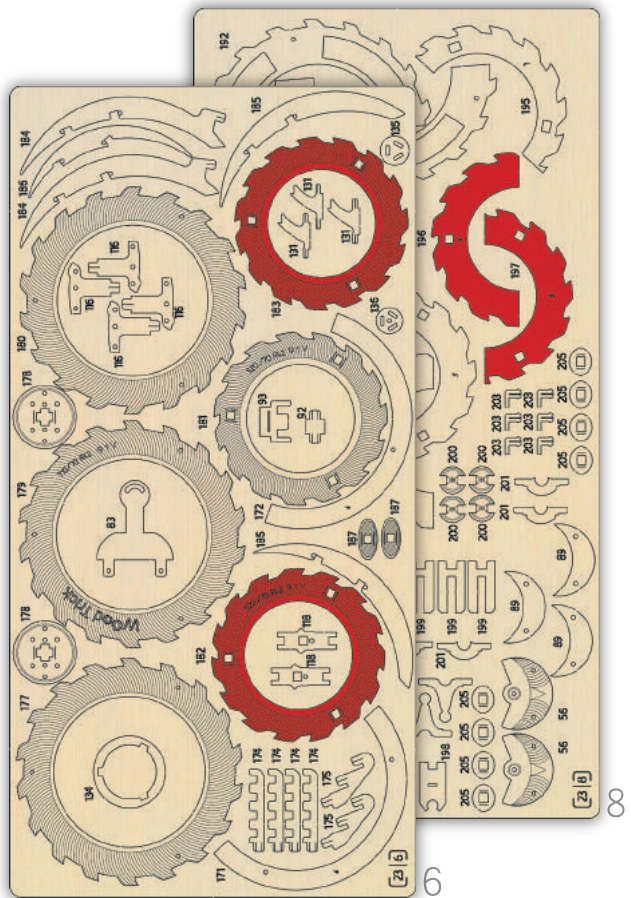

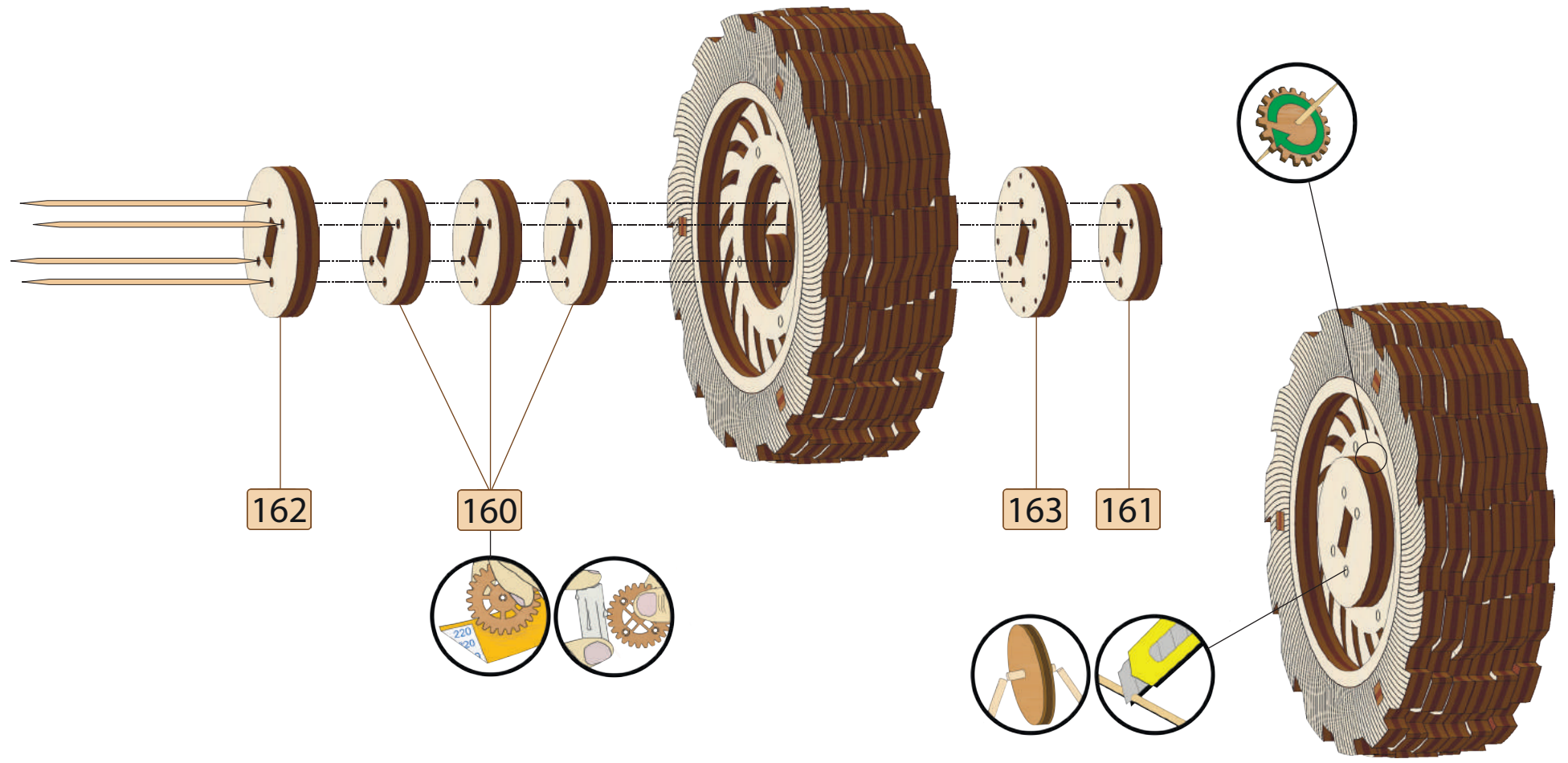
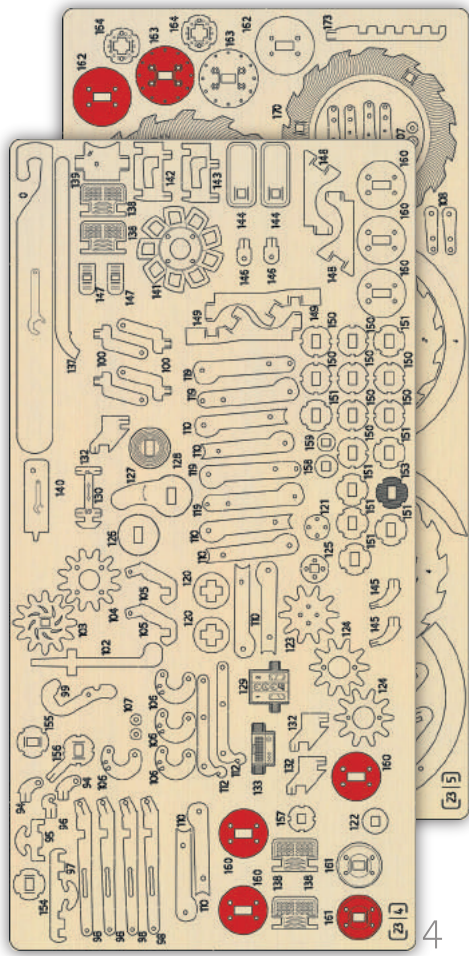

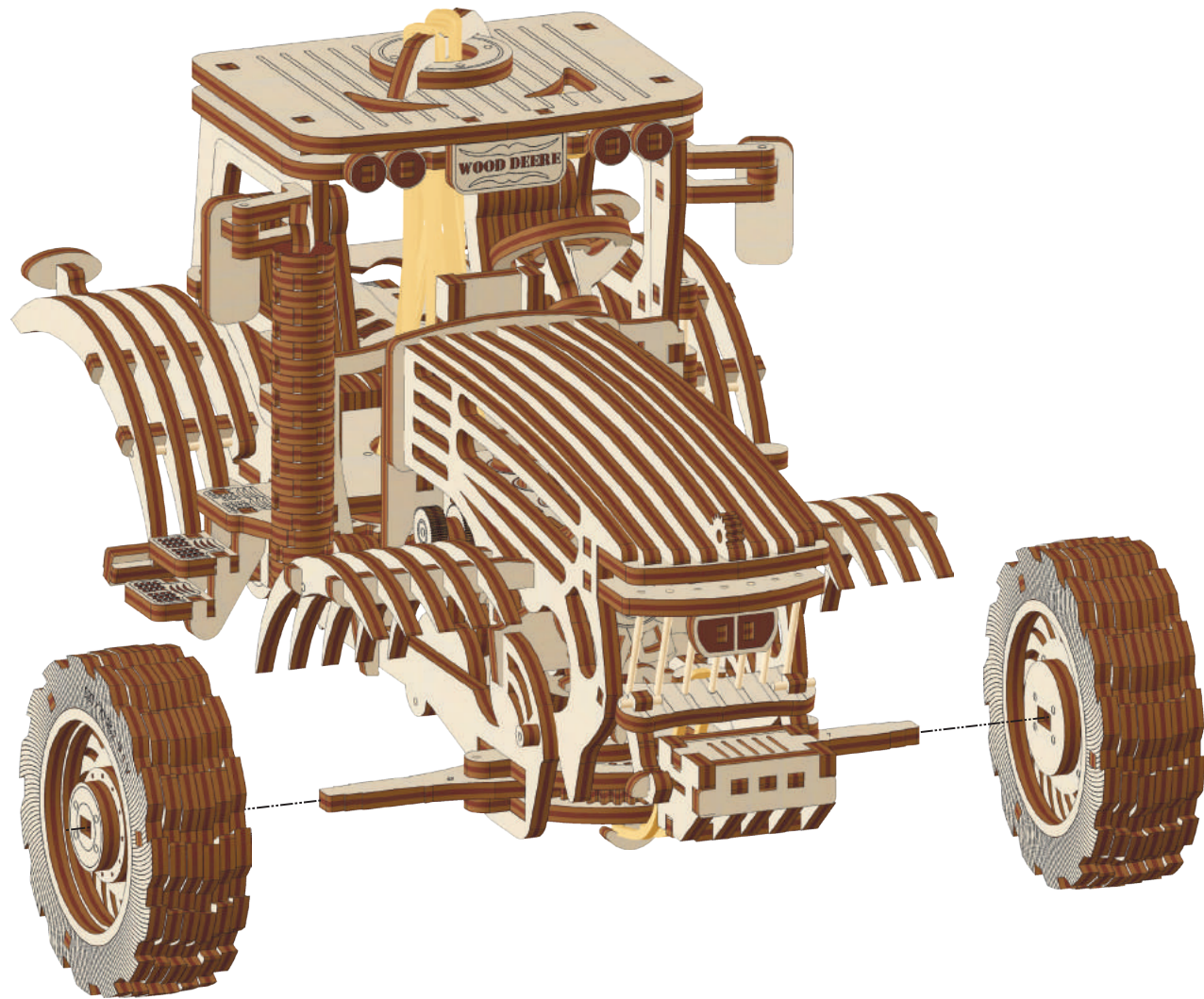



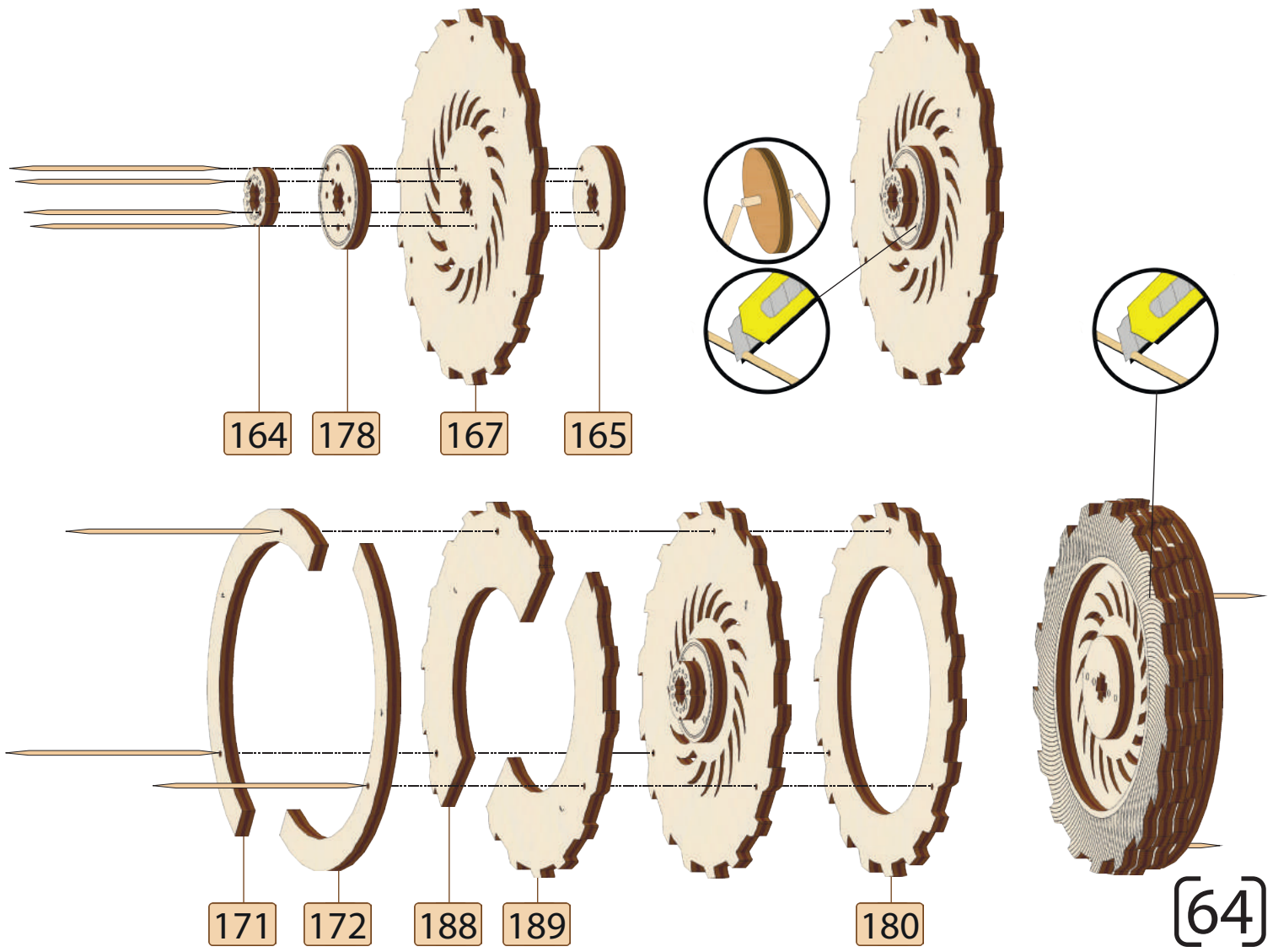

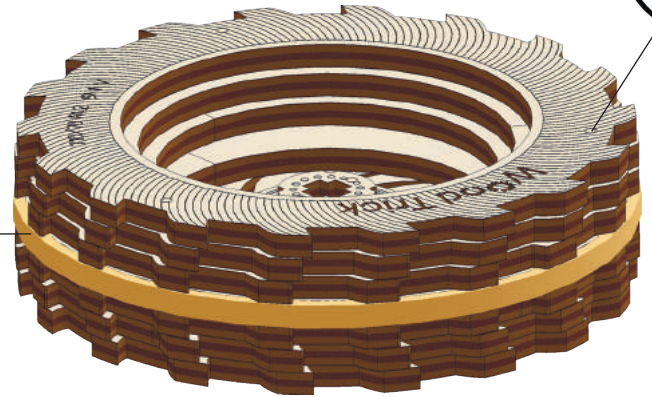
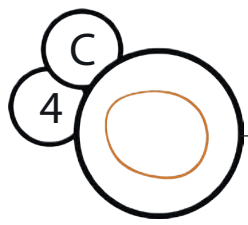
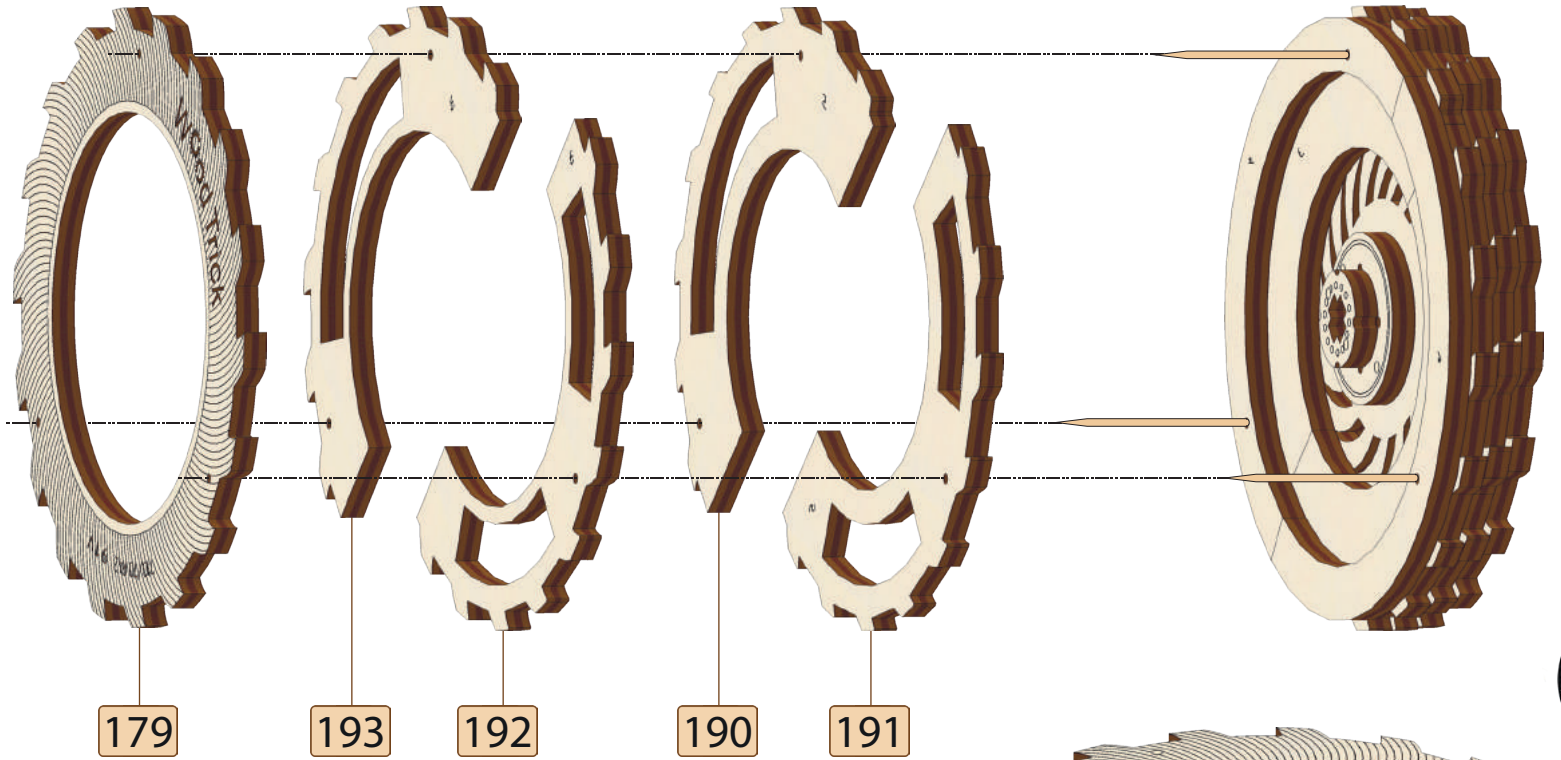
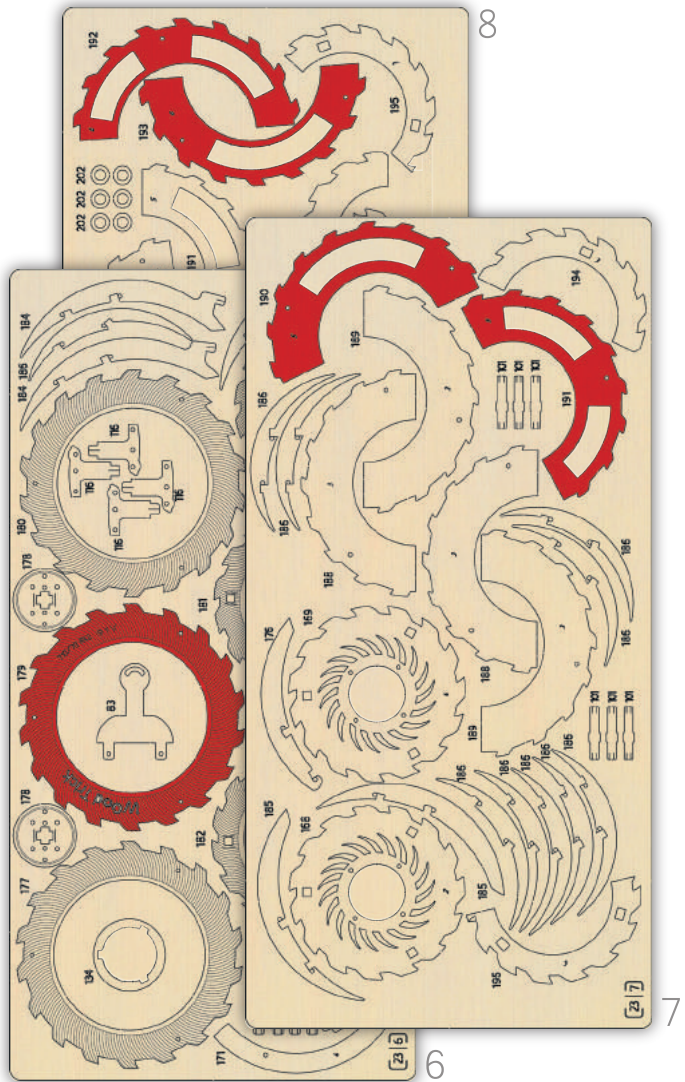

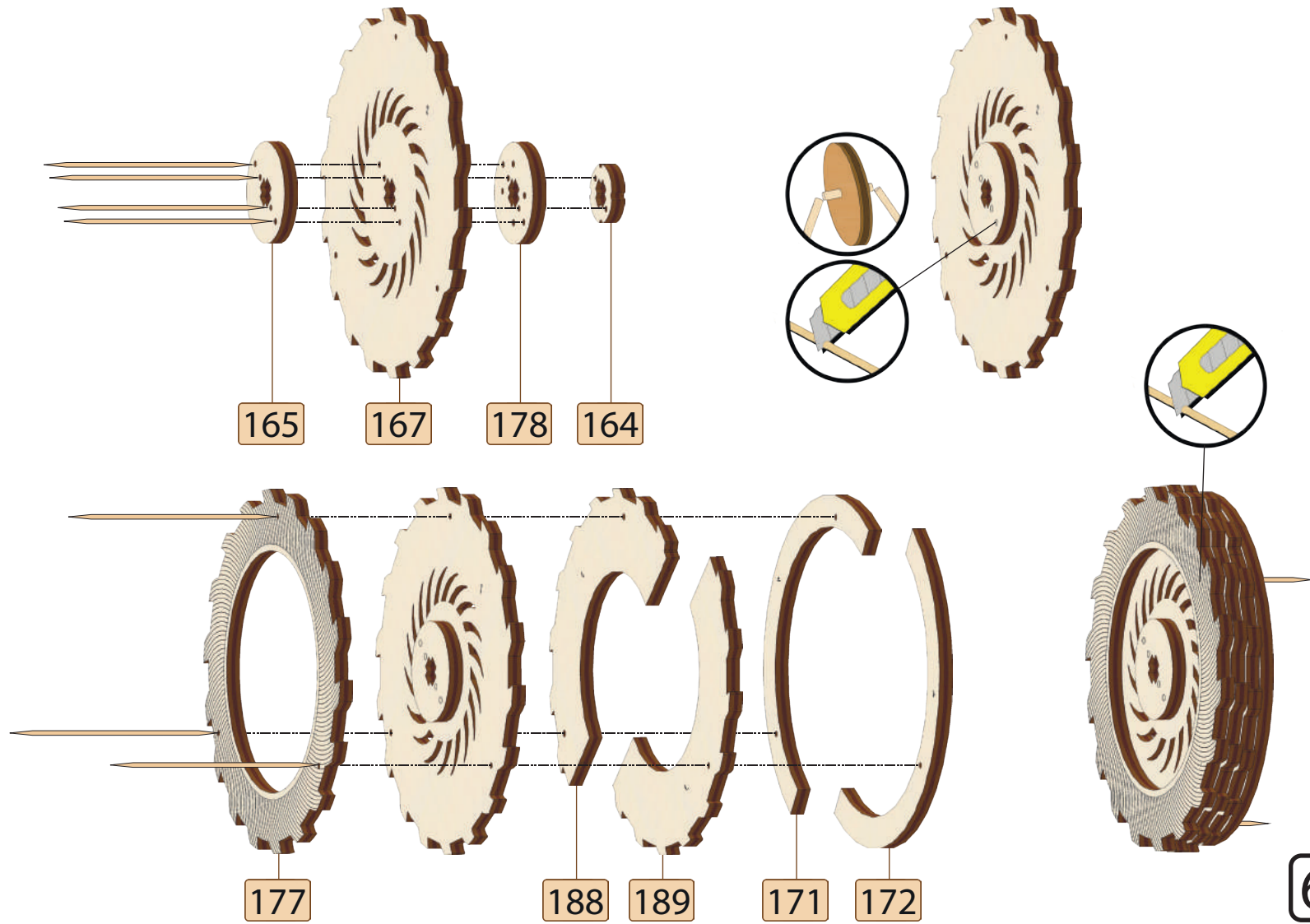

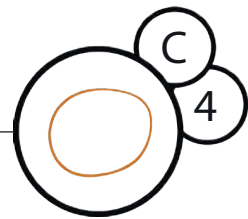
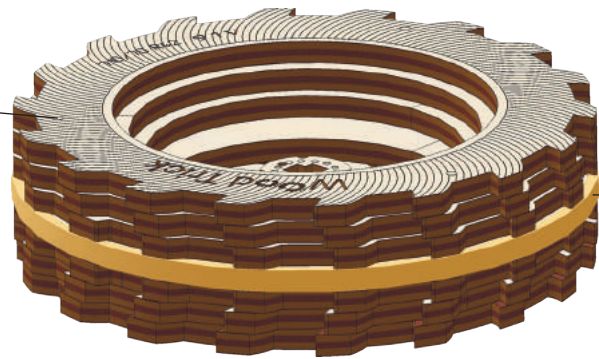
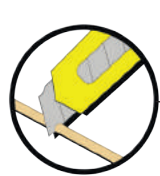
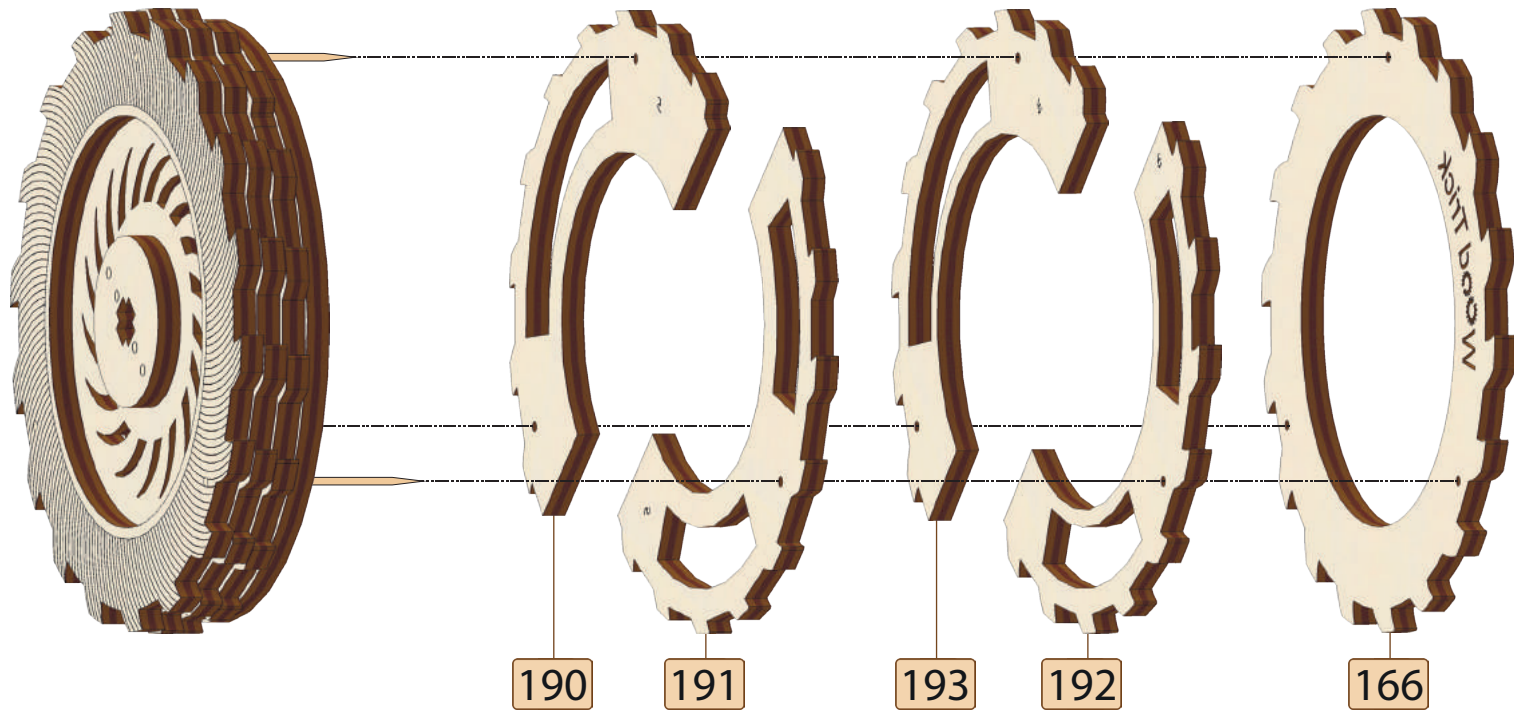

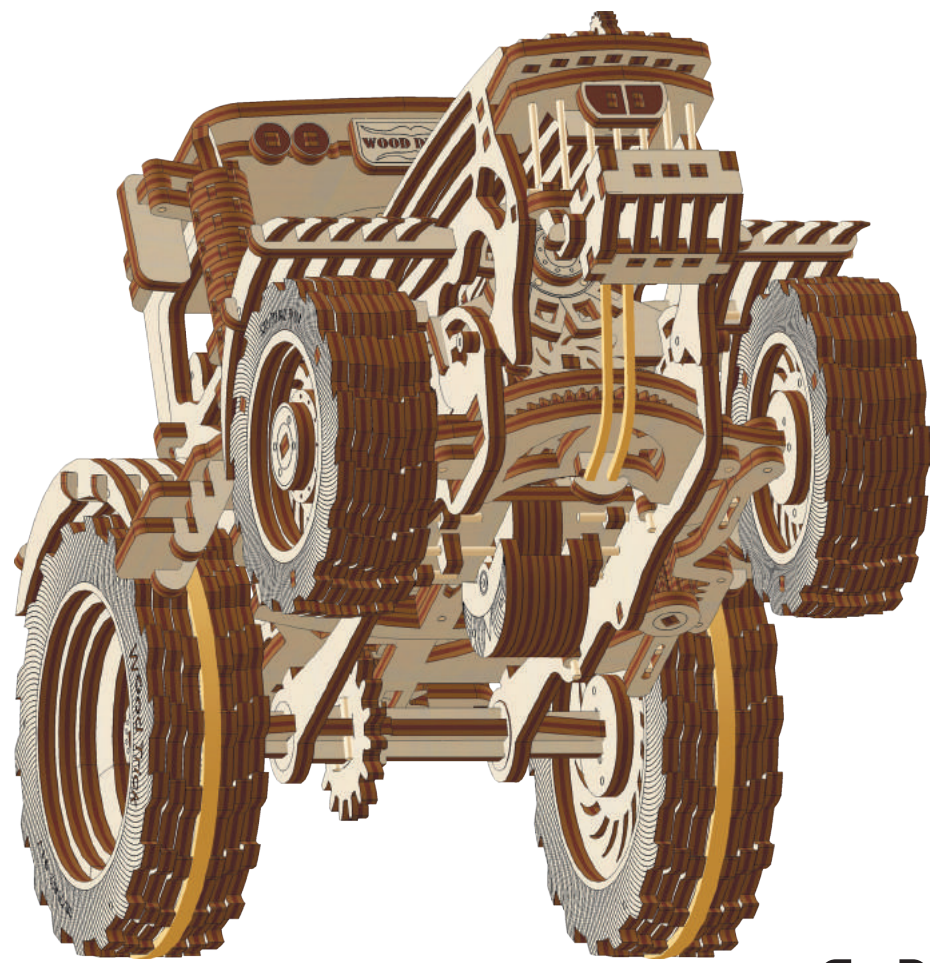
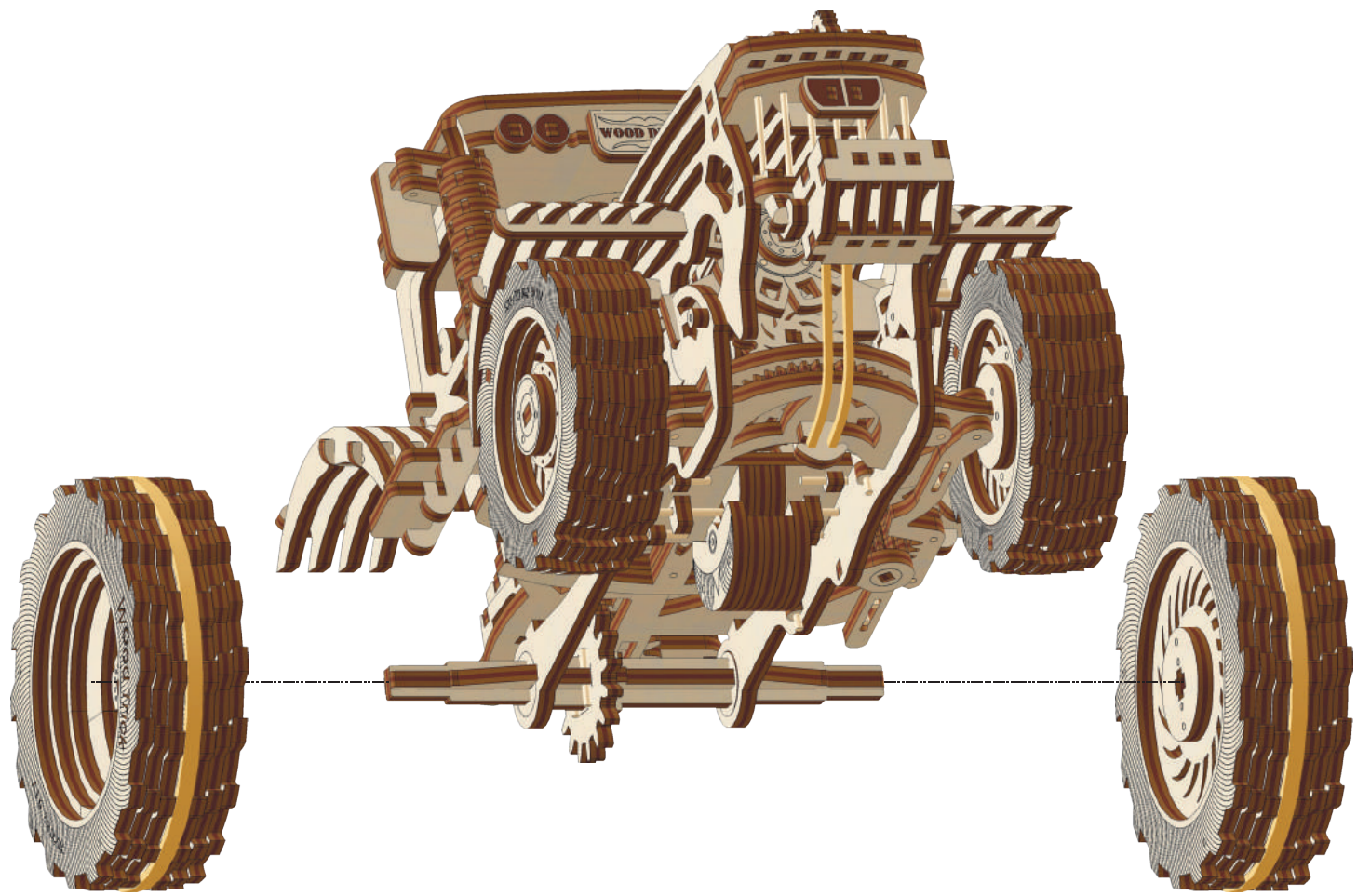

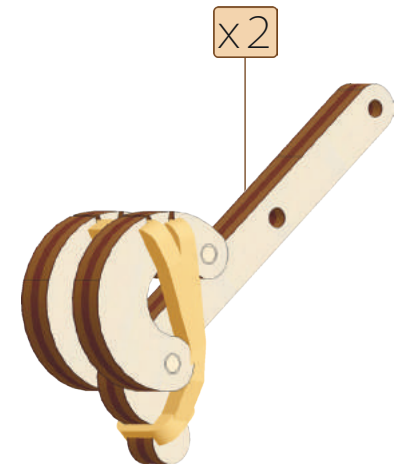
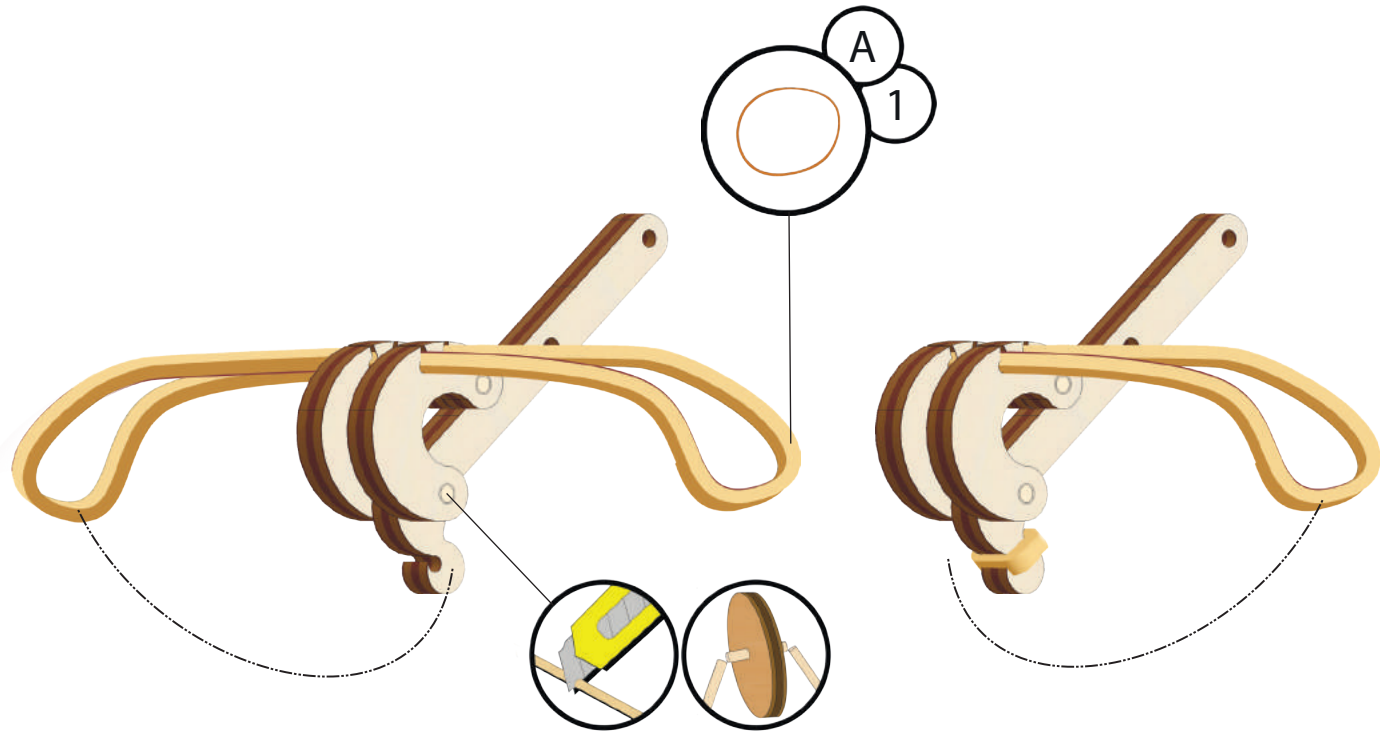
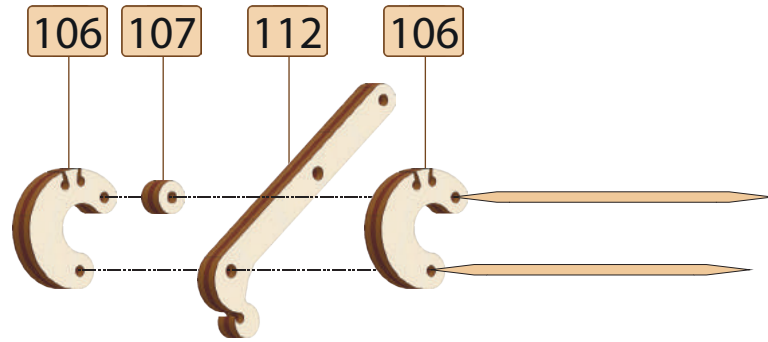
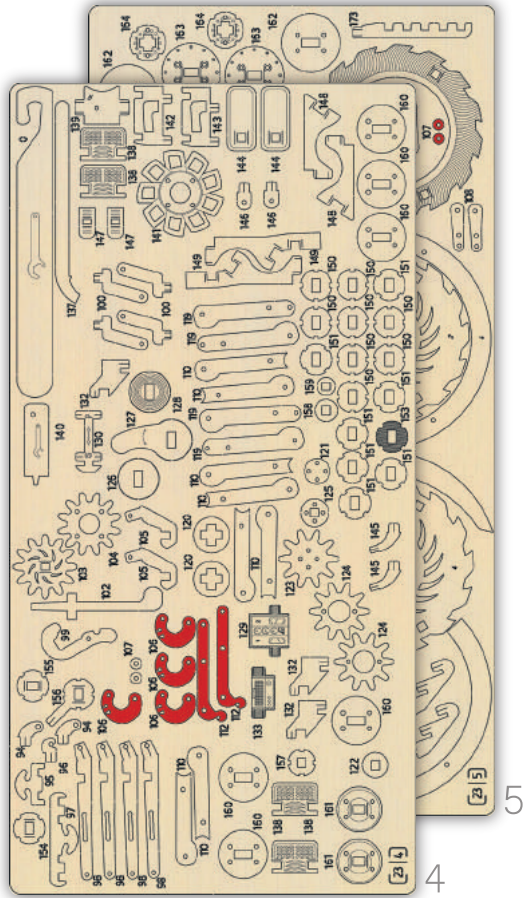

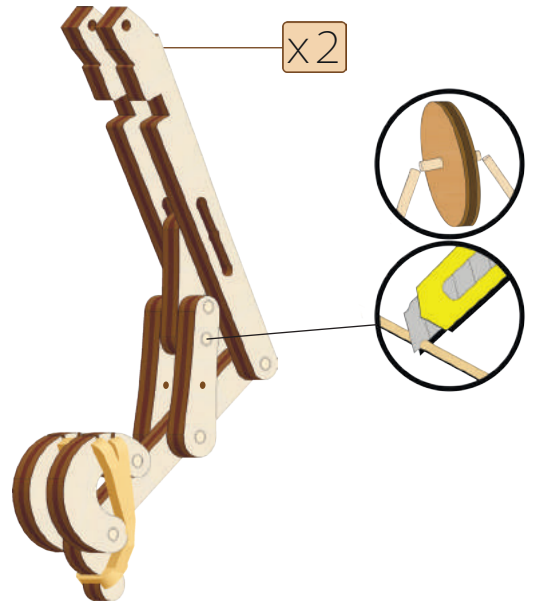
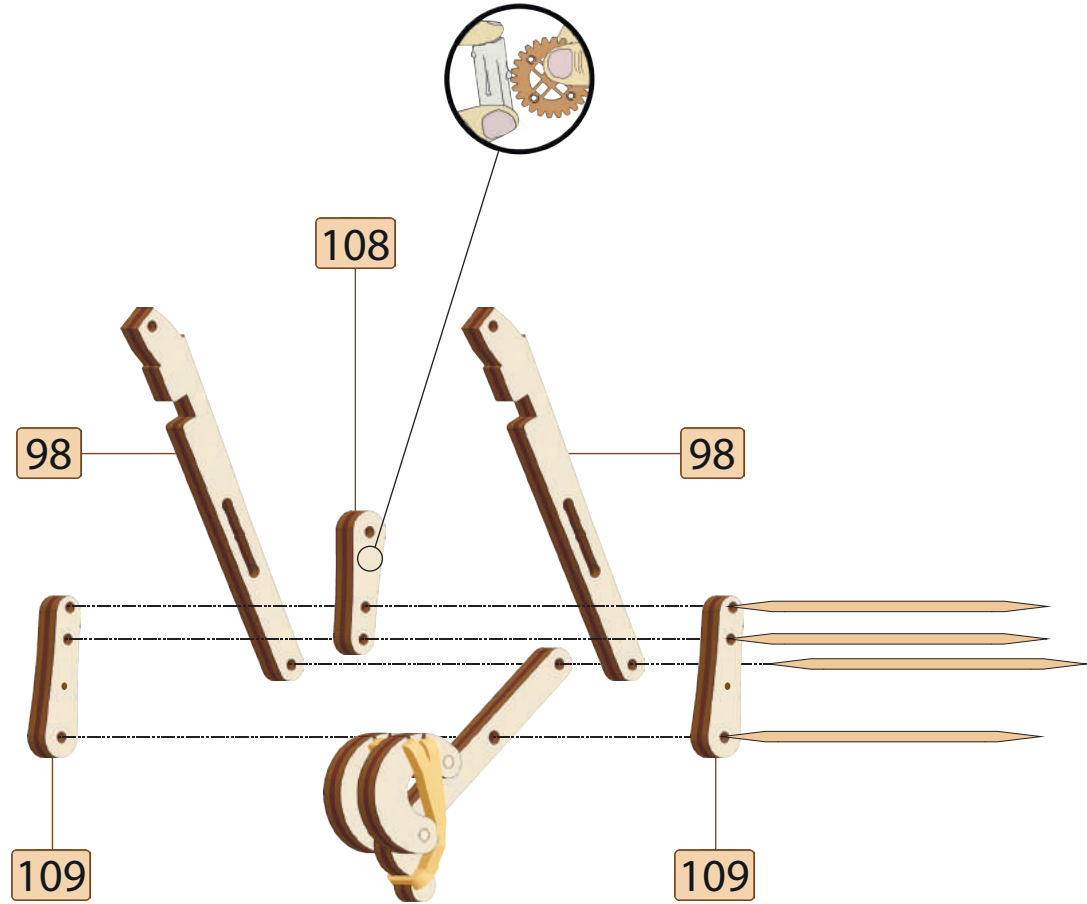
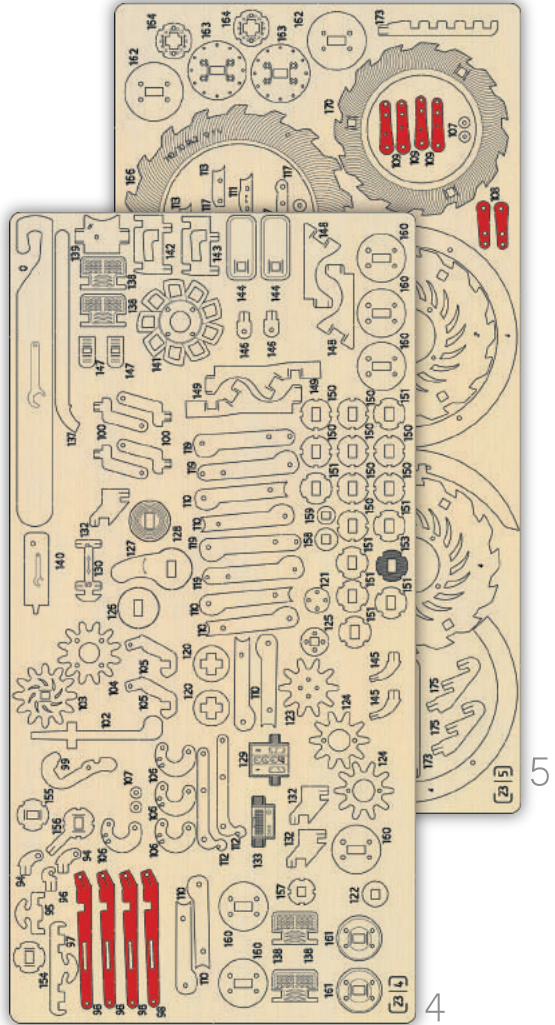

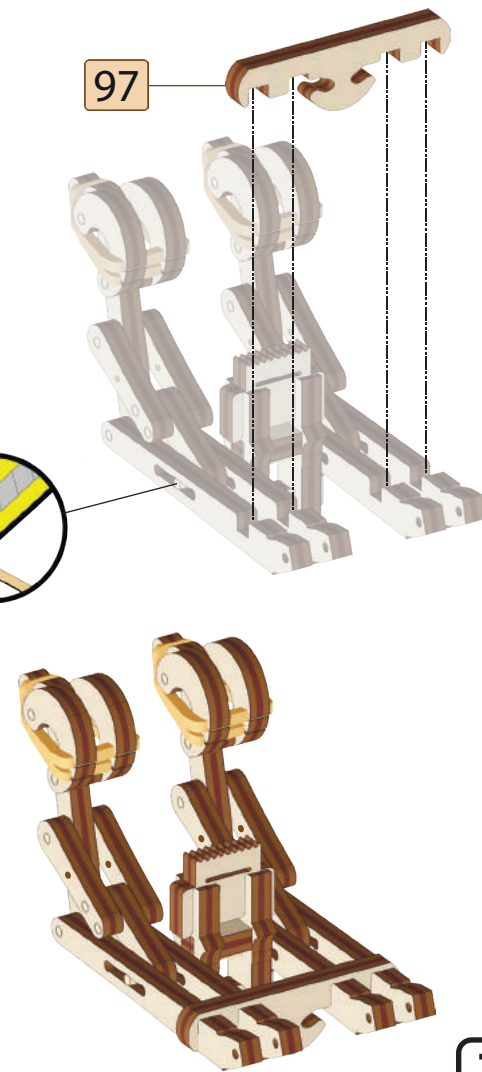
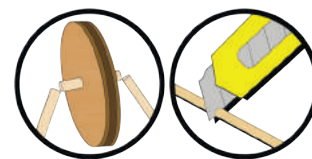
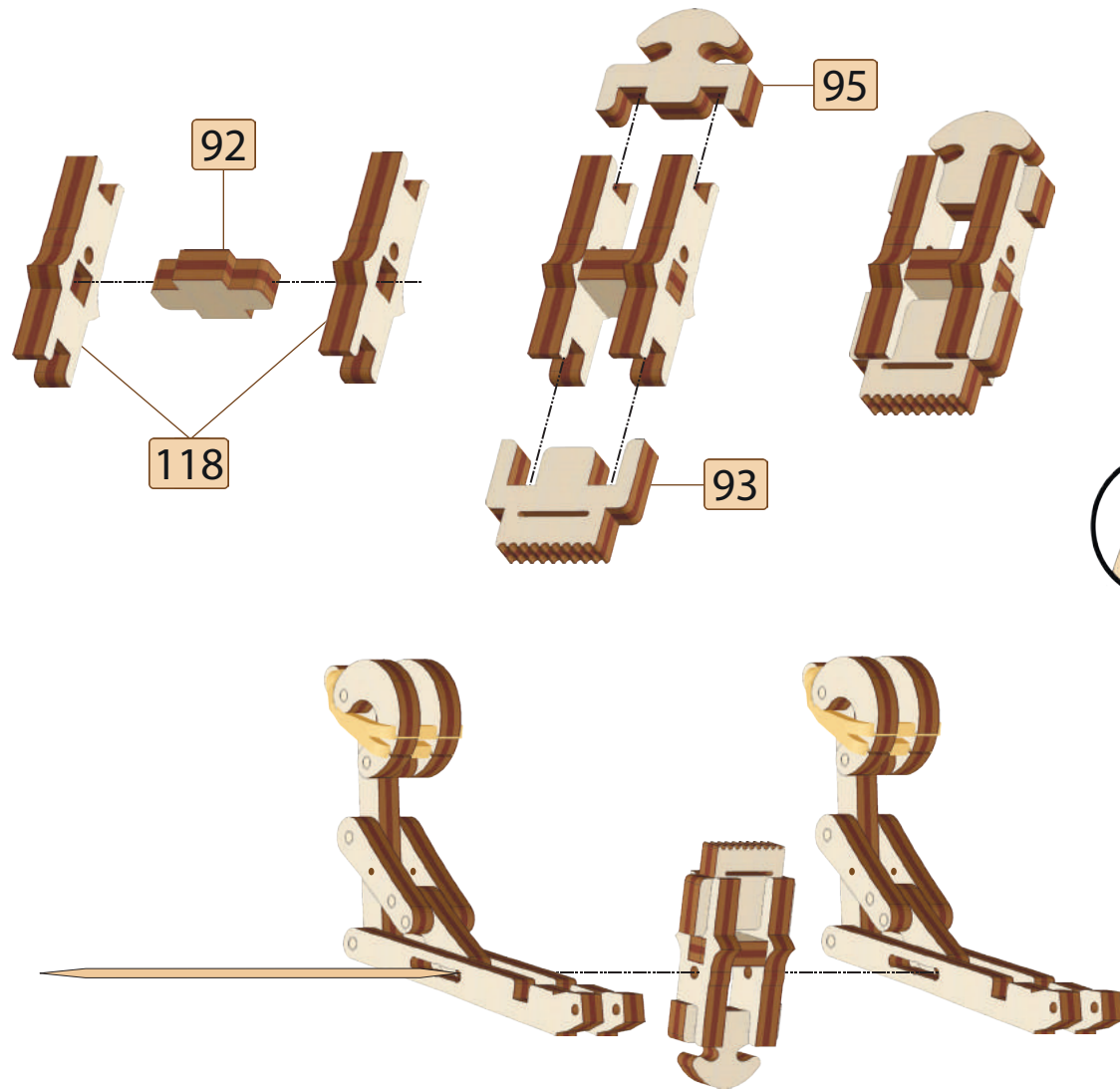
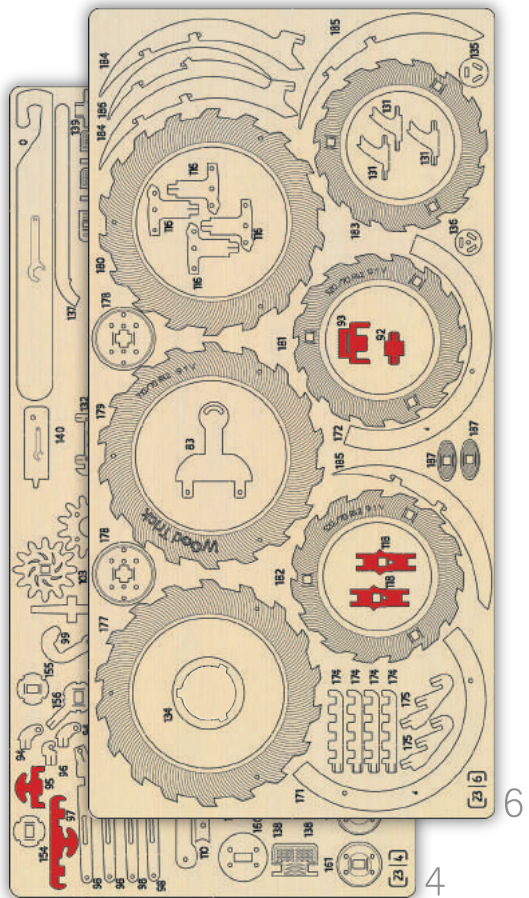



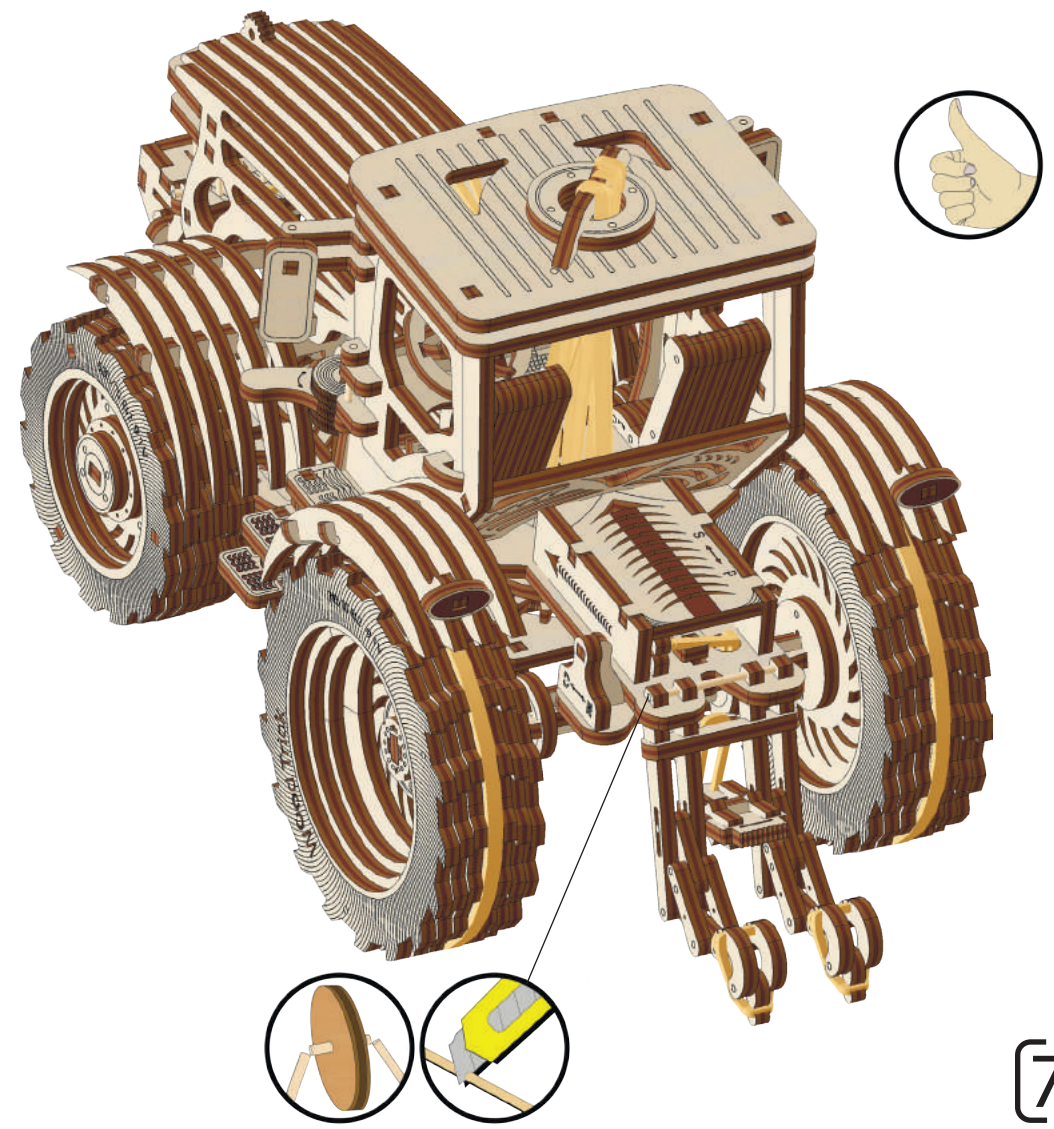
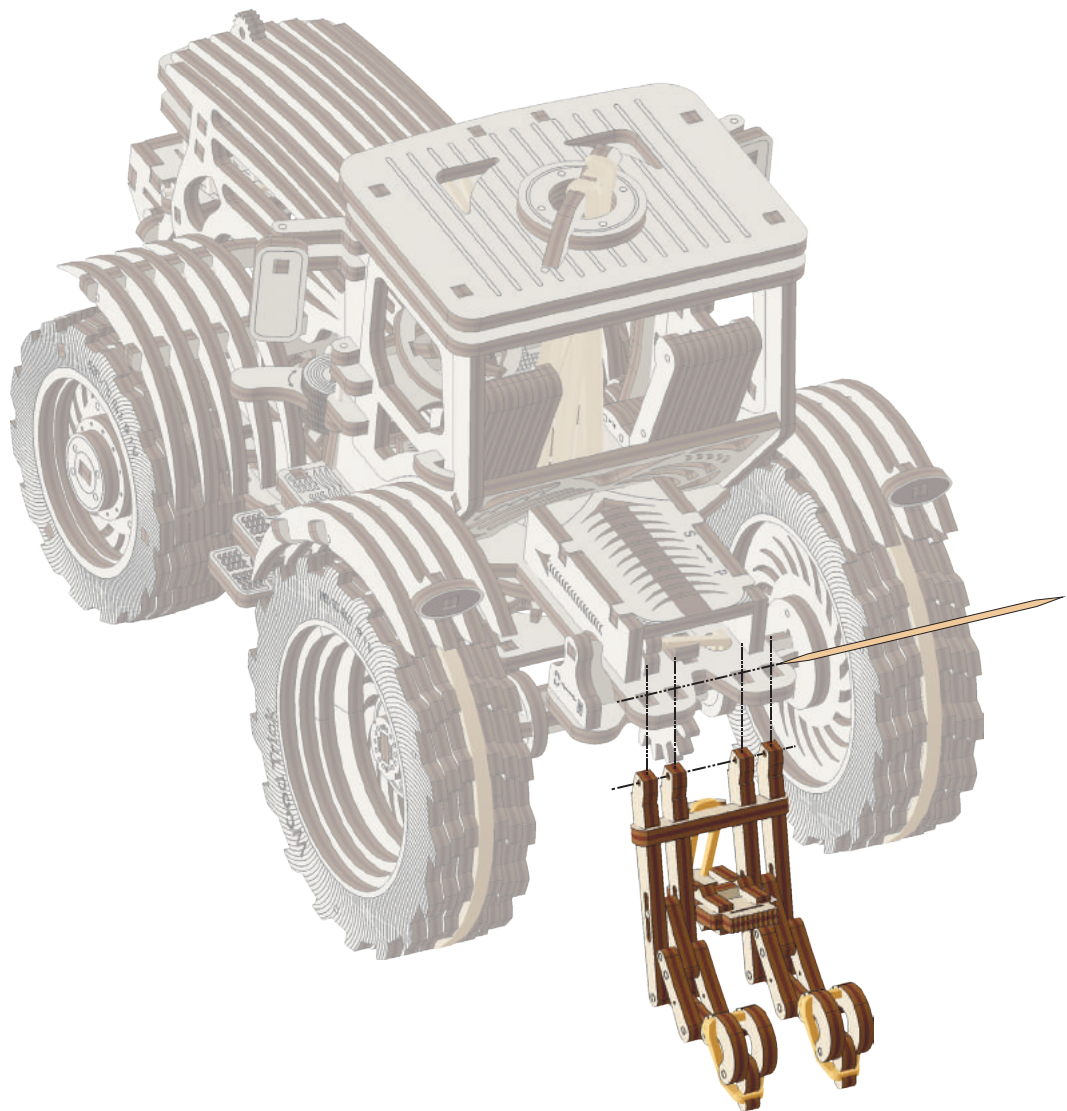

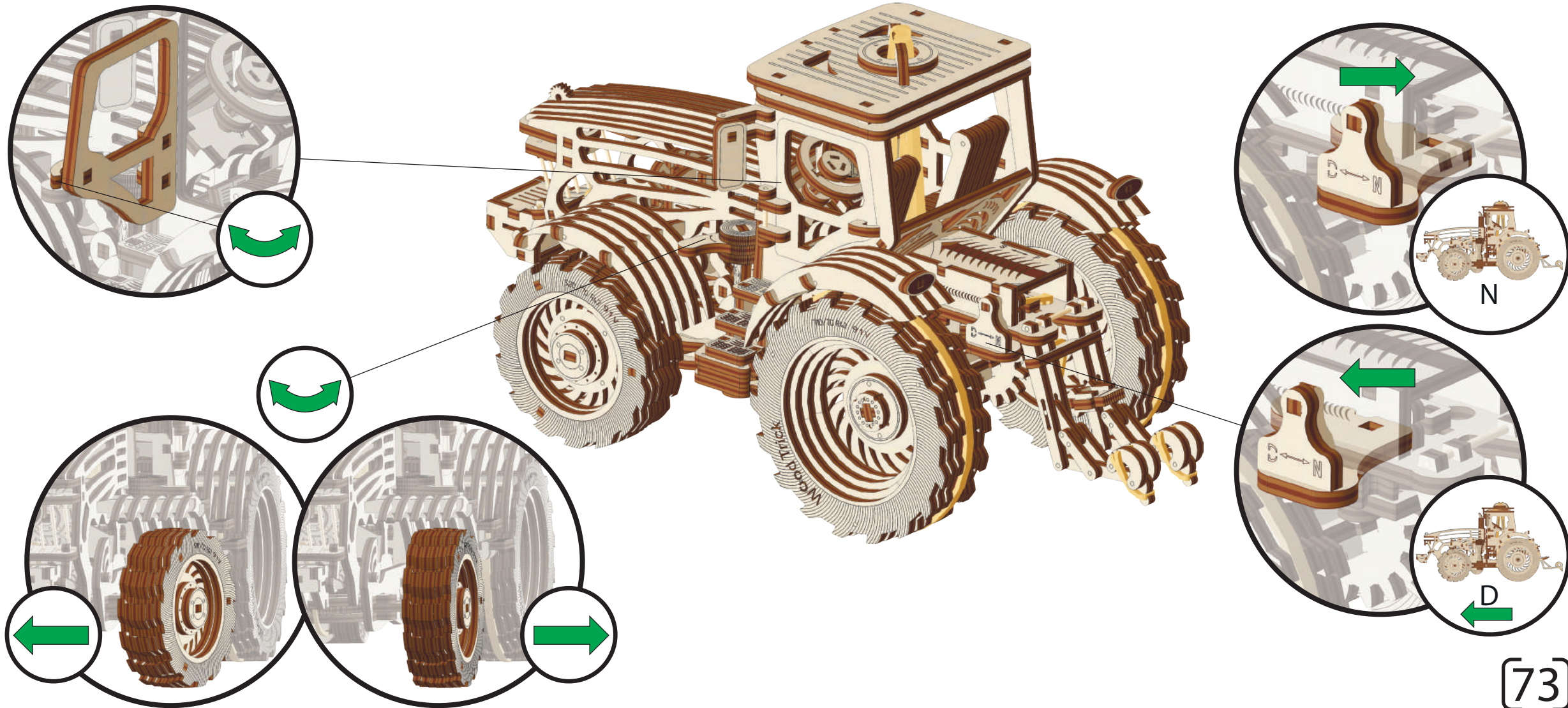

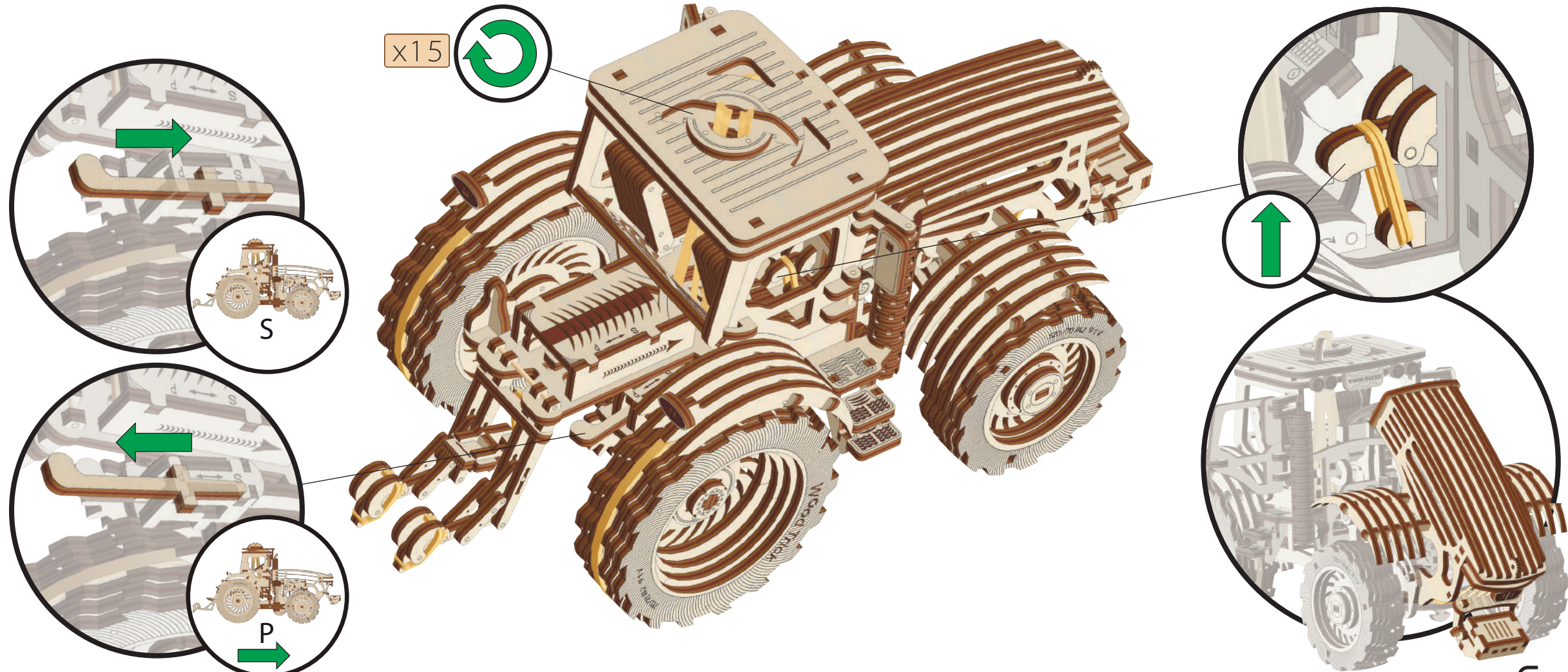

x15

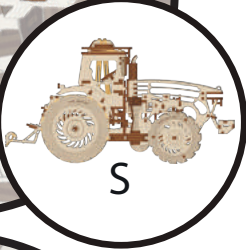

S

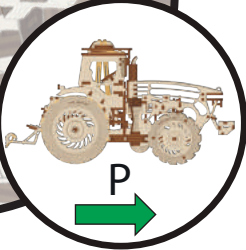

P

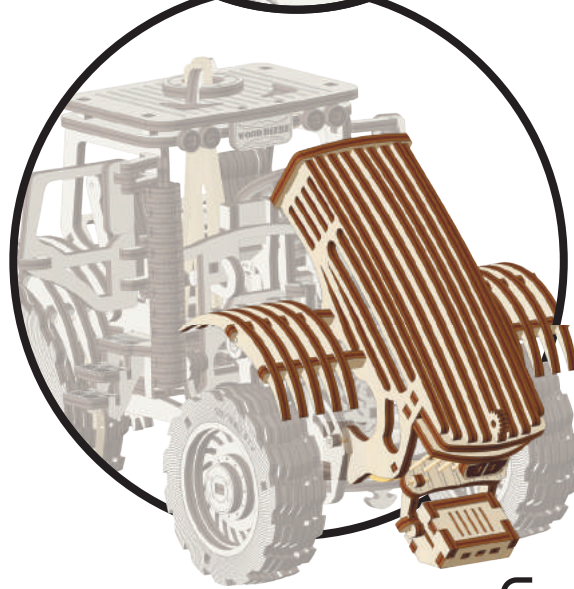



COLLECT A SET OF ADDITIONS

